

Agilent 86060C-Series Lightwave Switches User's Guide

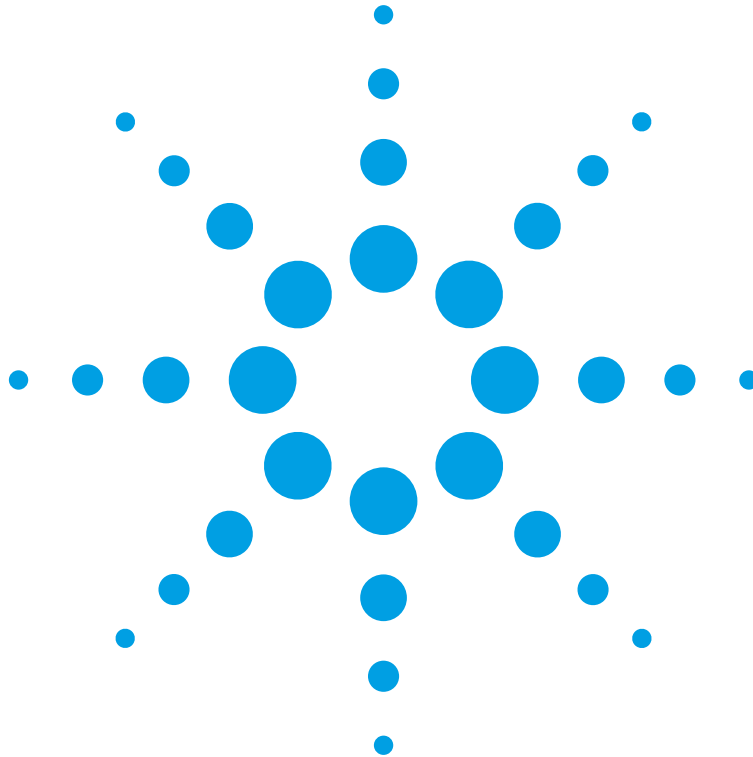

Agilent Technologies

© Copyright
Agilent Technologies 2000
All Rights Reserved. Reproduction, adaptation, or translation without prior written permission is prohibited, except as allowed under copyright laws.

Agilent Part No. 86060-90041
Printed in USA
March 2000

Agilent Technologies
Lightwave Division
1400 Fountaingrove Parkway
Santa Rosa, CA 95403-1799,
USA
(707) 577-1400

Notice.

The information contained in this document is subject to change without notice. Companies, names, and data used in examples herein are fictitious unless otherwise noted. Agilent Technologies makes no warranty of any kind with regard to this material, including but not limited to, the implied warranties of merchantability and fitness for a particular purpose. Agilent Technologies shall not be liable for errors contained herein or for incidental or consequential damages in connection with the furnishing, performance, or use of this material.

Restricted Rights Legend.

Use, duplication, or disclosure by the U.S. Government is subject to restrictions as set forth in subparagraph (c) (1) (ii) of the Rights in Technical Data and Computer Software clause at DFARS 252.227-7013 for DOD agencies, and subparagraphs (c) (1) and (c) (2) of the Commercial Computer Software Restricted Rights clause at FAR 52.227-19 for other agencies.

Warranty.

This Agilent Technologies instrument product is warranted against defects in

material and workmanship for a period of one year from date of shipment. During the warranty period, Agilent Technologies will, at its option, either repair or replace products which prove to be defective. For warranty service or repair, this product must be returned to a service facility designated by Agilent Technologies. Buyer shall prepay shipping charges to Agilent Technologies and Agilent Technologies shall pay shipping charges to return the product to Buyer. However, Buyer shall pay all shipping charges, duties, and taxes for products returned to Agilent Technologies from another country.

Agilent Technologies warrants that its software and firmware designated by Agilent Technologies for use with an instrument will execute its programming instructions when properly installed on that instrument. Agilent Technologies does not warrant that the operation of the instrument, or software, or firmware will be uninterrupted or error-free.

Limitation of Warranty.

The foregoing warranty shall not apply to defects resulting from improper or inadequate maintenance by Buyer, Buyer-supplied software or interfacing, unauthorized modification or misuse, operation outside of the environmental specifications for the product, or improper site preparation or maintenance.

No other warranty is expressed or implied. Agilent Technologies specifically disclaims the implied warranties of merchantability and fitness for a particular purpose.

Exclusive Remedies.

The remedies provided herein are buyer's sole and exclusive remedies. Agilent Technolo-

gies shall not be liable for any direct, indirect, special, incidental, or consequential damages, whether based on contract, tort, or any other legal theory.

Safety Symbols.

CAUTION

The *caution* sign denotes a hazard. It calls attention to a procedure which, if not correctly performed or adhered to, could result in damage to or destruction of the product. Do not proceed beyond a caution sign until the indicated conditions are fully understood and met.

WARNING

The *warning* sign denotes a hazard. It calls attention to a procedure which, if not correctly performed or adhered to, could result in injury or loss of life. Do not proceed beyond a warning sign until the indicated conditions are fully understood and met.



The instruction manual symbol. The product is marked with this warning symbol when it is necessary for the user to refer to the instructions in the manual.



The laser radiation symbol. This warning symbol is marked on products which have a laser output.



The AC symbol is used to indicate the required nature of the line module input power.



The ON symbols are used to mark the positions of the instrument power line switch.



The OFF symbols are used to mark the positions of the instrument power line switch.



The CE mark is a registered trademark of the European Community.



The CSA mark is a registered trademark of the Canadian Standards Association.



The C-Tick mark is a registered trademark of the Australian Spectrum Management Agency.

ISM1-A

This text denotes the instrument is an Industrial Scientific and Medical Group 1 Class A product.

Typographical Conventions.

The following conventions are used in this book:

Key type for keys or text located on the keyboard or instrument.

Softkey type for key names that are displayed on the instrument's screen.

Display type for words or characters displayed on the computer's screen or instrument's display.

User type for words or characters that you type or enter.

Emphasis type for words or characters that emphasize some point or that are used as place holders for text that you type.

General Safety Considerations

This product has been designed and tested in accordance with IEC Publication 61010-1, Safety Requirements for Electrical Equipment for Measurement, Control and Laboratory Use, and has been supplied in a safe condition. The instruction documentation contains information and warnings that must be followed by the user to ensure safe operation and to maintain the product in a safe condition.

WARNING

If this instrument is not used as specified, the protection provided by the equipment could be impaired. This instrument must be used in a normal condition (in which all means for protection are intact) only.

WARNING

To prevent electrical shock, disconnect the Agilent 86060C from mains before cleaning. Use a dry cloth or one slightly dampened with water to clean the external case parts. Do not attempt to clean internally.

WARNING

This is a Safety Class 1 product (provided with a protective earthing ground incorporated in the power cord). The mains plug shall only be inserted in a socket outlet provided with a protective earth contact. Any interruption of the protective conductor inside or outside of the product is likely to make the product dangerous. Intentional interruption is prohibited.

WARNING

No operator serviceable parts inside. Refer servicing to qualified personnel. To prevent electrical shock, do not remove covers.

WARNING

On Option 002 dual input instruments, any light on an unselected “A” channel will likely be output on one of the unselected “B” channels.

On Option 002 dual input instruments, any light on an unselected “B” channel will likely be output on an unselected “A” channel.

To avoid exposure to light energy, always cover all unused channels.

General Safety Considerations

WARNING

For continued protection against fire hazard, replace line fuse only with same type and ratings, (type T 0.315A/250V for 100/120V operation and 0.16A/250V for 220/240V operation). The use of other fuses or materials is prohibited. Verify that the value of the line-voltage fuse is correct.

- For 100/120V operation, use an IEC 127 5×20 mm, 0.315 A, 250 V, Agilent part number 2110-0449.
- For 220/240V operation, use an IEC 127 5×20 mm, 0.16 A, 250 V, Agilent Technologies part number 2110-0448.

CAUTION

Before switching on this instrument, make sure that the line voltage selector switch is set to the line voltage of the power supply and the correct fuse is installed. Assure the supply voltage is in the specified range.

CAUTION

This product is designed for use in Installation Category II and Pollution Degree 2 per IEC 1010 and 664 respectively.

CAUTION

VENTILATION REQUIREMENTS: When installing the product in a cabinet, the convection into and out of the product must not be restricted. The ambient temperature (outside the cabinet) must be less than the maximum operating temperature of the product by 4°C for every 100 watts dissipated in the cabinet. If the total power dissipated in the cabinet is greater than 800 watts, then forced convection must be used.

CAUTION

Always use the three-prong ac power cord supplied with this instrument. Failure to ensure adequate earth grounding by not using this cord may cause instrument damage.

CAUTION

Do not connect ac power until you have verified the line voltage is correct. Damage to the equipment could result.

CAUTION

This instrument has autoranging line voltage input. Be sure the supply voltage is within the specified range.

Contents

1 General Information

- Channels, Options, and Accessories 1-3
- Specifications and Regulatory Information 1-7
- Cleaning Connections for Accurate Measurements 1-12
- Returning the Instrument for Service 1-22
- Agilent Technologies Service Offices 1-25

2 Installing

- Step 1. Inspect the shipment 2-3
- Step 2. Check the fuse 2-4
- Step 3. Connect the line-power cable 2-5
- Power Cords 2-6
- Step 4. Turn on the lightwave switch 2-7
- Step 5. Performing an operational check 2-8
- If The Operational Check Fails 2-10

3 Using the Switch

- Front-Panel Features 3-3
- Rear-Panel Features 3-5
- Changing Switch Position 3-6
- Adjusting Display Contrast 3-7
- Saving Switch States 3-7

4 Programming

- General Information 4-3
- Programming over GPIB 4-6
- Programming over RS-232 4-8
- Common Commands 4-11
- Standard SCPI Commands 4-22
- Instrument Specific Commands 4-26
- Error Messages 4-30
- Programming Examples 4-31

5 Servicing

- Spare Channel Replacement Procedure 5-4
- Electrostatic Discharge Information 5-7

Channels, Options, and Accessories 1-3
Specifications and Regulatory Information 1-7
Cleaning Connections for Accurate Measurements 1-12
Returning the Instrument for Service 1-22
Agilent Technologies Service Offices 1-25

General Information

General Information

The Agilent 86060C-series lightwave switches cover a broad range of switching capacity and provide for accurate and repeatable measurements. Configuring the switch is easy because the signal routing is shown graphically on the display. You can easily integrate the switch into an automated test system using SCPI-compatible commands via GPIB or RS-232 interfaces. The Agilent 86060C-series lightwave switches are temperature stabilized.

- The Agilent 86060C is a compact switch with 4 to 8 output channels and 1 or 2 inputs.
- The HP 86061C is a mid-size switch in a half-width chassis, with 1 or 2 input channels. It can accommodate from 4 to 12 output channels on the front panel, and up to 18 outputs on the rear panel.
- The HP 86062C is a full-width switch with 20 to 100 output channels.

WARNING

On Option 002 dual input instruments, any light on an unselected “A” channel will likely be output on one of the unselected “B” channels.

On Option 002 dual input instruments, any light on an unselected “B” channel will likely be output on an unselected “A” channel.

To avoid exposure to light energy, always cover all unused channels.

CAUTION

Improper connector care, cleaning, or use of mismatched cable connectors can invalidate the published specifications and damage connectors. Clean all cables before applying to any connector. Repair of damaged connectors due to improper use is not covered under warranty. Refer to [“Cleaning Connections for Accurate Measurements” on page 1-12](#) for proper cleaning procedures.

CAUTION

OPTION 3XX INSTRUMENTS: To avoid damage, handle the pigtail fiber with care. Use only an appropriate fiber cleaver tool for cutting the fiber. Do not pull the bare fiber out of its jacket, crush it, kink it, or bend it past its minimum bend radius.

Channels, Options, and Accessories

Fiber-optic cables

The lightwave switch use one of three types of fiber-optic cables. To determine which fiber-optic cable type your lightwave switch uses, refer to the rear-panel serial number label. This label indicates the installed options which are defined in the following list:

- Option 109: 1280–1650 nm, 9/125 μm single-mode fiber
- Option 163: 750–1350 nm, 62.5/125 μm multimode fiber
- Option H51: 750–1350 nm, 50/125 μm multimode fiber

Switching is bi-directional

The lightwave switches are based on a moving fiber technology where an input fiber is aligned with any one of “N” fixed output fibers. The input fiber is positioned by means of a precision stepper motor. Lightwave switches with two input fibers allow the user to position either input A1 or A2 to a specific output channel. The non-selected input *may or may not* align with another output channel.

Lightwave switches with three or more “B” channels have an additional position called channel O or OFF.

Special ordered instruments

Normal lightwave switches have only one layer installed. (A switch layer is a switch matrix of “A” ports and “B” ports.) However, special ordered instruments may have multiple switch layers installed. If the rear panel shows more than one set of “A” ports and “B” ports, the instrument has multiple switch layers. Other switch configurations, such as non-blocking matrices are available as special orders.

Serial numbers

Agilent Technologies makes frequent improvements to its products to enhance their performance, usability, or reliability, and to control costs. Agilent Technologies service personnel have access to complete records of design changes to each type of equipment, based on the equipment’s serial number.

Channels, Options, and Accessories

Whenever you contact Agilent Technologies about your lightwave switch, have the complete serial number available to ensure obtaining the most complete and accurate information possible.

A serial-number label is attached to the rear of the lightwave switch. It contains the serial number and the options installed in the lightwave switch.

Whenever you specify the serial number or refer to it in obtaining information about your lightwave switch, be sure to use the complete number, including the full prefix and suffix.

Table 1-1. Output Channels

Agilent 86060C Compact Lightwave Switch	HP 86061C Mid-Size Lightwave Switch	HP 86062C Full-Size Lightwave Switch
Number of Output Channels		
04	04	20
06	08	24
08	12	28
	16	32
		40
		48
		56
		64
		72
		80
		00 (100 output channels)

Table 1-2. Options (1 of 2)

Option	Description
Number of Input Channels (select one):	
Option 001	Single input channel
Option 002	Two input channels
Wavelength and Fiber Type (select one):	
Option 109	1280–1650 nm, 9/125 μm single-mode fiber
Option 163	750–1350 nm, 62.5/125 μm multimode fiber
Option H51	750–1350 nm, 50/125 μm multimode fiber (special order)
Port Type (select one):	
Option 050	Connectors on front panel. (Only available on an Agilent 86060C or HP 86061C, with Option 204.)
Option 051	Connectors on rear panel. (For connectorized outputs only.)
Option 052	3 meter fiber out of the rear panel. (For connectorized outputs, the connector is at the end of the 3 meter fiber.)
Output Channels (select one):	
Option 2XX	Where XX is the number of connectorized output channels. (Note: Option 200 is 100 connectorized output channels.)
Option 3XX	Where XX is the number of non-connectorized output channels. (Note: Option 300 is 100 non-connectorized output channels.)
Connector Type (for connectorized ports or fibers only):	
Option 012	FC/PC connectors
Option 014	ST connectors
Option 017	SC connectors
	FC/APC or SC/APC connectors (special order)

Channels, Options, and Accessories**Table 1-2. Options (2 of 2)**

Option	Description
Optional Accessories	
Option ABJ	User's manual in Japanese
Option UK6	Commercial calibration certificate with test data
Option 1CM	Rack-mount flange kit
Option 1CN	Front handle kit
Option 1CP	Rack mount flange kit with handles

Table 1-3. Accessories

Agilent Part Number	Description
5062-3957	Rack mount adapter kit for a single half-width instrument.
5062-3977	Rack mount adapter kit for two adjacent half-width instruments.
5062-4079	Lock link kit for the Agilent 5062-3977.
5952-4079	<i>Fiber Optics Handbook</i> , an introduction to, and a reference for, fiber-optic measurements.

Specifications and Regulatory Information

This section lists specifications and regulatory information of the Agilent 86060C-series lightwave switches. Specifications apply over the temperature range +0°C to +55°C (unless otherwise noted). All specifications apply after the instrument's temperature has been stabilized after 120 minutes of continuous operation.

[Table 1-4 on page 1-8](#) lists specification, *characteristics*, and nominal values. The distinction between these terms is described as follows:

Specifications	Specifications describe warranted performance.
Characteristics	<i>Characteristics</i> provide useful information by giving functional, but nonwarranted, performance parameters. <i>Characteristics are printed in italics.</i>
Nominal values	Nominal value indicates the expected, but not warranted, value of the parameter.
Calibration cycle	Agilent Technologies warrants instrument specifications over the recommended calibration interval. To maintain specifications, periodic recalibrations are necessary. We recommend that the Agilent 86060C-series switches be calibrated at an Agilent Technologies service facility every 24 months.

CAUTION Improper connector care, cleaning, or use of mismatched cable connectors can invalidate the published specifications and damage connectors. Clean all cables before applying to any connector. Repair of damaged connectors due to improper use is not covered under warranty. Refer to [“Cleaning Connections for Accurate Measurements” on page 1-12](#) for proper cleaning procedures.

Specifications and Regulatory Information**Table 1-4. Optical Interface Specifications and Characteristics**

Insertion Loss^a	
Single-mode switches	1.0 dB (<i>0.7 dB</i>)
Multi-mode switches	0.8 dB (<i>0.6 dB</i>)
Insertion Loss Stability^b	±0.03 dB (<i>±0.025</i>)
Repeatability^c	
Sequential switching	±0.008 dB (<i>±0.005</i>)
Random switching	±0.025 dB (<i>±0.01</i>)
Optical Return Loss^d	
Single-mode	58 dB (<i>62 dB</i>)
Multimode	20 dB (<i>25 dB</i>)
Polarization Dependent Loss^e	0.05 dB (<i>0.02 dB</i>)
Isolation	-80 dB (<i>-100 dB</i>)
Typical Switching Life	10 million cycles, minimum
Switching Time	
Between adjacent channels	330 msec
Each additional channel	50 msec

- a. Insertion loss does not include connectors. Include an additional 0.5 dB (*0.25 dB characteristic*) for each connector.
- b. Drift of any channel relative to one assigned reference channel at ±3°C deviation of ambient temperature over 7 day period.
- c. Repeatability measured after four (4) hours warm-up and with a one (1) second pause between movements.
- d. Excludes external pigtail backscatter and connector reflections.
- e. Polarization dependent loss only applies to single-mode switches and is measured at 1550 nm.

Table 1-5. Switching Time Sample (msec)

Switch Size ^a	Switch	Starting Channel to Adjacent Channels	Plus Additional Time/Channel	Maximum ^b Switching Time
1×4	Agilent 86060C, HP 86061C	290	40	370
1×8	Agilent 86060C, HP 86061C	290	40	530
1×56	HP 86062C	258	7.5	663
1×100	HP 86062C	258	7.5	993

- a. Note that the switch mechanism used for channel count greater than 48 is different, hence switching time.
b. Switching time = (switching between starting and adjacent channel) + (additional time/channel) × remaining channel increments to reach last channel.

Table 1-6. General Specifications (1 of 2)

OPTICAL CONNECTORS^{a,b,c}	
Option 012	FC/PC connectors
Option 014	ST connectors
Option 017	SC connectors
GENERAL SPECIFICATIONS	
Temperature Range Operating Storage	+0°C to +55°C –40°C to +70°C
Humidity Operating Storage	Maximum relative humidity 95% for temperatures up to 40°C (non-condensing) Maximum relative humidity less than 90% at 65°C
Altitude	Altitude up to 15,000 feet (4,572 meters).
EMI Compatibility	Conducted and radiated emissions meet the requirements of CISPR Publication 11 and EN 55011 Group 1, Class A.
Power Requirements	100/115/230/240 V (<i>range 90 to 254 Vac</i>), 50/60 Hz (<i>range 47 to 63 Hz</i>)
Power Consumption	<i>Up to 80 VA</i>
Installation Category	Category II per I.E.C. 1010
Pollution Degree	Degree 2 per I.E.C. 664
Usage	For indoor use.
Enclosure Protection	IP 2 0, according to IEC 529

General Information
Specifications and Regulatory Information

Table 1-6. General Specifications (2 of 2)

Weight (dependent on # of channels)	
Agilent 86060C	3.76 kg to 4.1 kg (8.4 lb to 9.2 lb)
HP 86061C	4.0 kg to 6.18 kg (8.8 lb to 13.6 lb)
HP 86062C	7.72 kg to 13.74 kg (17.25 lb to 30.7 lb)
Dimensions (H × W × D) ^d	
Agilent 86060C	132.6 × 213 × 345.4 mm (5.25 × 8.39 × 14 in)
HP 86061C	177 × 213 × 345.4 mm (7 × 8.39 × 14 in)
HP 86062C	177 × 425 × 345.4 mm (7 × 16.75 × 14 in)

- a. All Agilent 86060C-series lightwave switches must specify one of the following options, except when specifying Option 3xx.
 b. Unlike most Agilent Technologies lightwave instruments, connector types are not interchangeable.
 c. Other connector types are available upon request.
 d. Feet add 12.5 mm to the height of the instrument.

Regulatory Information

This instrument is in conformance with the German Regulation on Noise Declaration for Machines (Laermangabe nach der Maschinenlaermverordnung –3.GSGV Deutschland).

Notice for Germany: Noise Declaration

Acoustic Noise Emission	Geraeuschemission
LpA < 70 dB	LpA < 70 dB
Operator position	am Arbeitsplatz
Normal position	normaler Betrieb
per ISO 7779	nach DIN 45635 t.19

DECLARATION OF CONFORMITY

according to ISO/IEC Guide 22 and EN 45014

Manufacturer's Name: Hewlett-Packard Co.

Manufacturer's Address: 1400 Fountaingrove Parkway
Santa Rosa, CA 95403-1799
USA

declares that the products:

Product Name: 86060C-Series Lightwave Switches

Model Number: HP 86060C, HP 86061C, HP 86062C

Product Options: This declaration covers all options of the above products.

conform to the following Product specifications:

Safety IEC 1010-1:1990+A1 /EN 61010-1:1993
CAN/CSA-C22.2 No. 1010.1-92

EMC: CISPR 11:1990/EN 55011:1991 Group 1, Class A
IEC 801-2:1984/EN 50082-1:1992 4 kV CD, 8 kV AD
IEC 801-3:1984/EN 50082-1:1992 3V/m, 27-500 MHz
IEC 801-4:1984/EN 50082-1:1992 0.5 kV sig. lines, 1 kV power lines

Supplementary Information:

The products herewith comply with the requirements of the Low Voltage Directive 73/23/EEC and the EMC Directive 89/336/EEC and carry the CE-marking accordingly.

Santa Rosa, CA, USA 19 June 1998



Greg Pfeiffer/Quality Engineering Manager

European Contact: Your local Hewlett-Packard Sales and Service Office or Hewlett-Packard GmbH, Department HQ-TRE, Herrenberger Strasse 130, D-71034 Böblingen, Germany (Fax +49-7031-14-3143)

Cleaning Connections for Accurate Measurements

Today, advances in measurement capabilities make connectors and connection techniques more important than ever. Damage to the connectors on calibration and verification devices, test ports, cables, and other devices can degrade measurement accuracy and damage instruments. Replacing a damaged connector can cost thousands of dollars, not to mention lost time! This expense can be avoided by observing the simple precautions presented in this book. This book also contains a brief list of tips for caring for electrical connectors.

Choosing the Right Connector

A critical but often overlooked factor in making a good lightwave measurement is the selection of the fiber-optic connector. The differences in connector types are mainly in the mechanical assembly that holds the ferrule in position against another identical ferrule. Connectors also vary in the polish, curve, and concentricity of the core within the cladding. Mating one style of cable to another requires an adapter. Agilent Technologies offers adapters for most instruments to allow testing with many different cables. [Figure 1-1 on page 1-13](#) shows the basic components of a typical connectors.

The system tolerance for reflection and insertion loss must be known when selecting a connector from the wide variety of currently available connectors. Some items to consider when selecting a connector are:

- How much insertion loss can be allowed?
- Will the connector need to make multiple connections? Some connectors are better than others, and some are very poor for making repeated connections.
- What is the reflection tolerance? Can the system take reflection degradation?
- Is an instrument-grade connector with a precision core alignment required?
- Is repeatability tolerance for reflection and loss important? Do your specifica-

Cleaning Connections for Accurate Measurements

tions take repeatability uncertainty into account?

- Will a connector degrade the return loss too much, or will a fusion splice be required? For example, many DFB lasers cannot operate with reflections from connectors. Often as much as 90 dB isolation is needed.

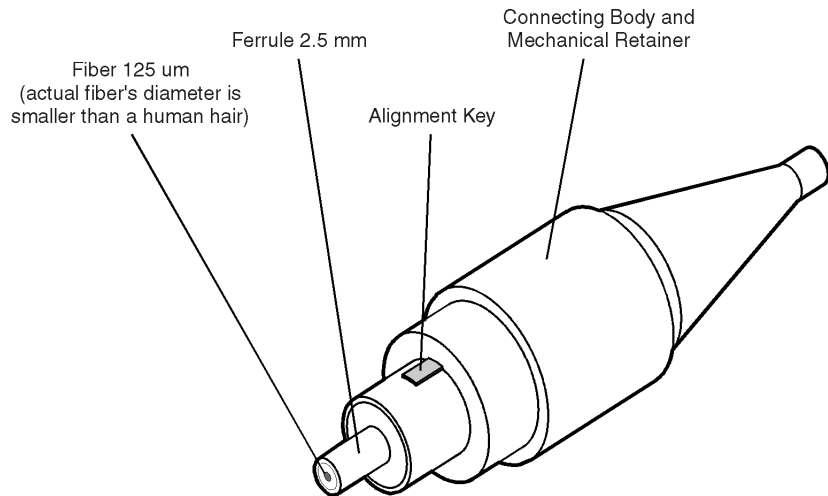

Figure 1-1. Basic components of a connector.

Over the last few years, the FC/PC style connector has emerged as the most popular connector for fiber-optic applications. While not the highest performing connector, it represents a good compromise between performance, reliability, and cost. If properly maintained and cleaned, this connector can withstand many repeated connections.

However, many instrument specifications require tighter tolerances than most connectors, including the FC/PC style, can deliver. These instruments cannot tolerate connectors with the large non-concentricities of the fiber common with ceramic style ferrules. When tighter alignment is required, Agilent Technologies instruments typically use a connector such as the Diamond HMS-10, which has concentric tolerances within a few tenths of a micron. Agilent Technologies then uses a special universal adapter, which allows other cable types to mate with this precision connector. See [Figure 1-2](#).

Cleaning Connections for Accurate Measurements



Figure 1-2. Universal adapters to Diamond HMS-10.

The HMS-10 encases the fiber within a soft nickel silver (Cu/Ni/Zn) center which is surrounded by a tough tungsten carbide casing, as shown in [Figure 1-3](#).

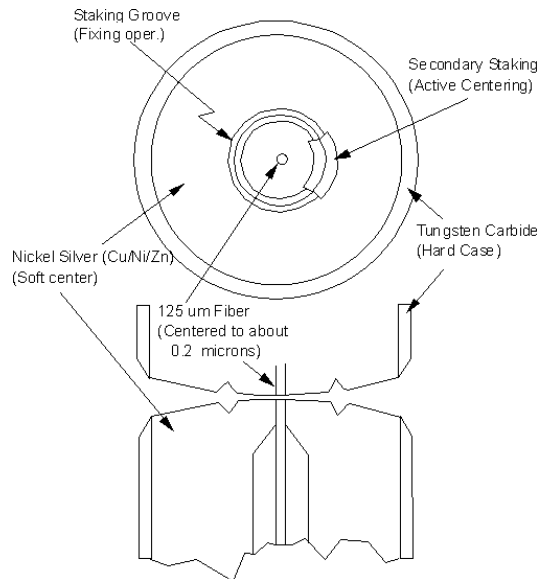

Figure 1-3. Cross-section of the Diamond HMS-10 connector.

The nickel silver allows an active centering process that permits the glass fiber to be moved to the desired position. This process first stakes the soft nickel silver to fix the fiber in a near-center location, then uses a post-active staking to shift the fiber into the desired position within 0.2 μm . This process, plus the keyed axis, allows very precise core-to-core alignments. This connector is found on most Agilent Technologies lightwave instruments.

The soft core, while allowing precise centering, is also the chief liability of the connector. The soft material is easily damaged. Care must be taken to minimize excessive scratching and wear. While minor wear is not a problem if the glass face is not affected, scratches or grit can cause the glass fiber to move out of alignment. Also, if unkeyed connectors are used, the nickel silver can be pushed onto the glass surface. Scratches, fiber movement, or glass contamination will cause loss of signal and increased reflections, resulting in poor return loss.

Inspecting Connectors

Because fiber-optic connectors are susceptible to damage that is not immediately obvious to the naked eye, poor measurements result without the user being aware. Microscopic examination and return loss measurements are the best way to ensure good measurements. Good cleaning practices can help ensure that optimum connector performance is maintained. With glass-to-glass interfaces, any degradation of a ferrule or the end of the fiber, any stray particles, or finger oil can have a significant effect on connector performance. Where many repeat connections are required, use of a connector saver or patch cable is recommended.

[Figure 1-4](#) shows the end of a clean fiber-optic cable. The dark circle in the center of the micrograph is the fiber's 125 μm core and cladding which carries the light. The surrounding area is the soft nickel-silver ferrule. [Figure 1-5](#) shows a dirty fiber end from neglect or perhaps improper cleaning. Material is smeared and ground into the end of the fiber causing light scattering and poor reflection. Not only is the precision polish lost, but this action can grind off the glass face and destroy the connector.

[Figure 1-6](#) shows physical damage to the glass fiber end caused by either repeated connections made without removing loose particles or using improper cleaning tools. When severe, the damage of one connector end can be transferred to another good connector endface that comes in contact with the damaged one. Periodic checks of fiber ends, and replacing connecting cables after many connections is a wise practice.

The cure for these problems is disciplined connector care as described in the following list and in [“Cleaning Connectors” on page 1-19](#).

Cleaning Connections for Accurate Measurements

Use the following guidelines to achieve the best possible performance when making measurements on a fiber-optic system:

- Never use metal or sharp objects to clean a connector and never scrape the connector.
- Avoid matching gel and oils.

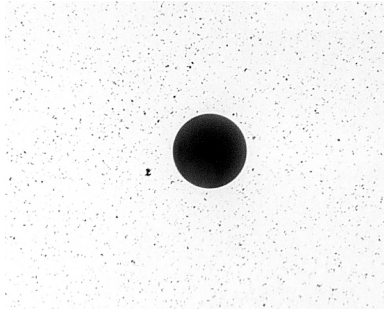

Figure 1-4. Clean, problem-free fiber end and ferrule.

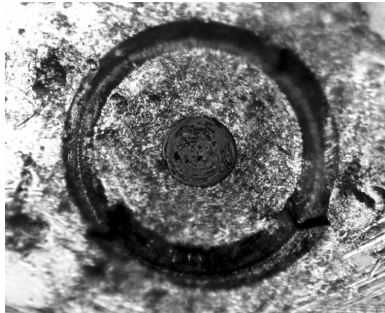

Figure 1-5. Dirty fiber end and ferrule from poor cleaning.

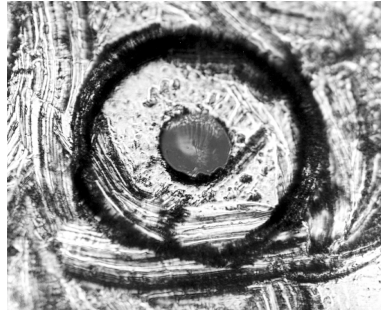

Figure 1-6. Damage from improper cleaning.

While these often work well on first insertion, they are great dirt magnets. The oil or gel grabs and holds grit that is then ground into the end of the fiber. Also, some early gels were designed for use with the FC, non-contacting connectors, using small glass spheres. When used with contacting connectors, these glass balls can scratch and pit the fiber. If an index matching gel or oil must be used, apply it to a freshly cleaned connector, make the measurement, and then immediately clean it off. Never use a gel for longer-term connections and never use it to improve a damaged connector. The gel can mask the extent of damage and continued use of a damaged fiber can transfer damage to the instrument.

- When inserting a fiber-optic cable into a connector, gently insert it in as straight a line as possible. Tipping and inserting at an angle can scrape material off the inside of the connector or even break the inside sleeve of connectors made with ceramic material.
- When inserting a fiber-optic connector into a connector, make sure that the fiber end does not touch the outside of the mating connector or adapter.
- Avoid over tightening connections.

Unlike common electrical connections, tighter is *not* better. The purpose of the connector is to bring two fiber ends together. Once they touch, tightening only causes a greater force to be applied to the delicate fibers. With connectors that have a convex fiber end, the end can be pushed off-axis resulting in misalignment and excessive return loss. Many measurements are actually improved by backing off the connector pressure. Also, if a piece of grit does happen to get by the cleaning procedure, the tighter connection is more likely to damage the glass. Tighten the connectors just until the two fibers touch.

Cleaning Connections for Accurate Measurements

- Keep connectors covered when not in use.
- Use fusion splices on the more permanent critical nodes. Choose the best connector possible. Replace connecting cables regularly. Frequently measure the return loss of the connector to check for degradation, and clean every connector, every time.

All connectors should be treated like the high-quality lens of a good camera. The weak link in instrument and system reliability is often the inappropriate use and care of the connector. Because current connectors are so easy to use, there tends to be reduced vigilance in connector care and cleaning. It takes only one missed cleaning for a piece of grit to permanently damage the glass and ruin the connector.

Measuring insertion loss and return loss

Consistent measurements with your lightwave equipment are a good indication that you have good connections. Since return loss and insertion loss are key factors in determining optical connector performance they can be used to determine connector degradation. A smooth, polished fiber end should produce a good return-loss measurement. The quality of the polish establishes the difference between the “PC” (physical contact) and the “Super PC” connectors. Most connectors today are physical contact which make glass-to-glass connections, therefore it is critical that the area around the glass core be clean and free of scratches. Although the major area of a connector, excluding the glass, may show scratches and wear, if the glass has maintained its polished smoothness, the connector can still provide a good low level return loss connection.

If you test your cables and accessories for insertion loss and return loss upon receipt, and retain the measured data for comparison, you will be able to tell in the future if any degradation has occurred. Typical values are less than 0.5 dB of loss, and sometimes as little as 0.1 dB of loss with high performance connectors. Return loss is a measure of reflection: the less reflection the better (the larger the return loss, the smaller the reflection). The best physically contacting connectors have return losses better than 50 dB, although 30 to 40 dB is more common.

Visual inspection of fiber ends

Visual inspection of fiber ends can be helpful. Contamination or imperfections on the cable end face can be detected as well as cracks or chips in the fiber itself. Use a microscope (100X to 200X magnification) to inspect the entire end face for contamination, raised metal, or dents in the metal as well as any other imperfections. Inspect the fiber for cracks and chips. Visible imperfections not touching the fiber core may not affect performance (unless the imperfections keep the fibers from contacting).

WARNING

Always remove both ends of fiber-optic cables from any instrument, system, or device before visually inspecting the fiber ends. Disable all optical sources before disconnecting fiber-optic cables. Failure to do so may result in permanent injury to your eyes.

Cleaning Connectors

The procedures in this section provide the proper steps for cleaning fiber-optic cables and Agilent Technologies universal adapters. The initial cleaning, using the alcohol as a solvent, gently removes any grit and oil. If a caked-on layer of material is still present, (this can happen if the beryllium-copper sides of the ferrule retainer get scraped and deposited on the end of the fiber during insertion of the cable), a second cleaning should be performed. It is not uncommon for a cable or connector to require more than one cleaning.

CAUTION

Agilent Technologies strongly recommends that index matching compounds *not* be applied to their instruments and accessories. Some compounds, such as gels, may be difficult to remove and can contain damaging particulates. If you think the use of such compounds is necessary, refer to the compound manufacturer for information on application and cleaning procedures.

Table 1-7. Cleaning Accessories

Item	Agilent Part Number
Any commercially available denatured alcohol	—
Cotton swabs	8520-0023
Small foam swabs	9300-1223
Compressed dust remover (non-residue)	8500-5262

Cleaning Connections for Accurate Measurements**Table 1-8. Dust Caps Provided with Lightwave Instruments**

Item	Agilent Part Number
Laser shutter cap	08145-64521
FC/PC dust cap	08154-44102
Biconic dust cap	08154-44105
DIN dust cap	5040-9364
HMS10/dust cap	5040-9361
ST dust cap	5040-9366

To clean a non-lensed connector**CAUTION**

Do not use any type of foam swab to clean optical fiber ends. Foam swabs can leave filmy deposits on fiber ends that can degrade performance.

- 1** Apply pure isopropyl alcohol to a clean lint-free cotton swab or lens paper.
Cotton swabs can be used as long as no cotton fibers remain on the fiber end after cleaning.
- 2** Clean the ferrules and other parts of the connector while avoiding the end of the fiber.
- 3** Apply isopropyl alcohol to a new clean lint-free cotton swab or lens paper.
- 4** Clean the fiber end with the swab or lens paper.
Do *not* scrub during this initial cleaning because grit can be caught in the swab and become a gouging element.
- 5** Immediately dry the fiber end with a clean, dry, lint-free cotton swab or lens paper.
- 6** Blow across the connector end face from a distance of 6 to 8 inches using filtered, dry, compressed air. Aim the compressed air at a shallow angle to the fiber end face.

Nitrogen gas or compressed dust remover can also be used.

CAUTION

Do not shake, tip, or invert compressed air canisters, because this releases particles in the can into the air. Refer to instructions provided on the compressed air canister.

- 7 As soon as the connector is dry, connect or cover it for later use.

If the performance, after the initial cleaning, seems poor try cleaning the connector again. Often a second cleaning will restore proper performance. The second cleaning should be more arduous with a scrubbing action.

To clean an adapter

The fiber-optic input and output connectors on many Agilent Technologies instruments employ a universal adapter such as those shown in the following picture. These adapters allow you to connect the instrument to different types of fiber-optic cables.



Figure 1-7. Universal adapters.

- 1 Apply isopropyl alcohol to a clean foam swab.

Cotton swabs can be used as long as no cotton fibers remain after cleaning. The foam swabs listed in this section's introduction are small enough to fit into adapters.

Although foam swabs can leave filmy deposits, these deposits are very thin, and the risk of other contamination buildup on the inside of adapters greatly outweighs the risk of contamination by foam swabs.

- 2 Clean the adapter with the foam swab.
- 3 Dry the inside of the adapter with a clean, dry, foam swab.
- 4 Blow through the adapter using filtered, dry, compressed air.

Nitrogen gas or compressed dust remover can also be used. Do not shake, tip, or invert compressed air canisters, because this releases particles in the can into the air. Refer to instructions provided on the compressed air canister.

Returning the Instrument for Service

The instructions in this section show you how to properly return the instrument for repair or calibration. Always call the Agilent Technologies Instrument Support Center first to initiate service *before* returning your instrument to a service office. This ensures that the repair (or calibration) can be properly tracked and that your instrument will be returned to you as quickly as possible. Call this number regardless of where you are located. Refer to “Agilent Technologies Service Offices” on page 1-25 for a list of service offices.

Agilent Technologies Instrument Support Center (800) 403-0801

If the instrument is still under warranty or is covered by an Agilent Technologies maintenance contract, it will be repaired under the terms of the warranty or contract (the warranty is at the front of this manual). If the instrument is no longer under warranty or is not covered by an Agilent Technologies maintenance plan, Agilent Technologies will notify you of the cost of the repair after examining the unit.

When an instrument is returned to a Agilent Technologies service office for servicing, it must be adequately packaged and have a complete description of the failure symptoms attached. When describing the failure, please be as specific as possible about the nature of the problem. Include copies of additional failure information (such as the instrument failure settings, data related to instrument failure, and error messages) along with the instrument being returned.

Preparing the instrument for shipping

- 1 Write a complete description of the failure and attach it to the instrument. Include any specific performance details related to the problem. The following

information should be returned with the instrument.

- Type of service required.
 - Date instrument was returned for repair.
 - Description of the problem:
 - Whether problem is constant or intermittent.
 - Whether instrument is temperature-sensitive.
 - Whether instrument is vibration-sensitive.
 - Instrument settings required to reproduce the problem.
 - Performance data.
 - Company name and return address.
 - Name and phone number of technical contact person.
 - Model number of returned instrument.
 - Full serial number of returned instrument.
 - List of any accessories returned with instrument.
- 2** Cover all front or rear-panel connectors that were originally covered when you first received the instrument.

CAUTION

Cover electrical connectors to protect sensitive components from electrostatic damage. Cover optical connectors to protect them from damage due to physical contact or dust.

CAUTION

Instrument damage can result from using packaging materials other than the original materials. Never use styrene pellets as packaging material. They do not adequately cushion the instrument or prevent it from shifting in the carton. They may also cause instrument damage by generating static electricity.

- 3** Pack the instrument in the original shipping containers. Original materials are available through any Agilent Technologies office. Or, use the following guidelines:
- Wrap the instrument in antistatic plastic to reduce the possibility of damage caused by electrostatic discharge.
 - For instruments weighing less than 54 kg (120 lb), use a double-walled, corrugated cardboard carton of 159 kg (350 lb) test strength.
 - The carton must be large enough to allow approximately 7 cm (3 inches) on all sides of the instrument for packing material, and strong enough to accommodate the weight of the instrument.
 - Surround the equipment with approximately 7 cm (3 inches) of packing material, to protect the instrument and prevent it from moving in the carton. If packing foam is not available, the best alternative is S.D-240 Air Cap™ from

Returning the Instrument for Service

Sealed Air Corporation (Commerce, California 90001). Air Cap looks like a plastic sheet filled with air bubbles. Use the pink (antistatic) Air Cap™ to reduce static electricity. Wrapping the instrument several times in this material will protect the instrument and prevent it from moving in the carton.

- 4** Seal the carton with strong nylon adhesive tape.
- 5** Mark the carton “FRAGILE, HANDLE WITH CARE”.
- 6** Retain copies of all shipping papers.

Agilent Technologies Service Offices

Before returning an instrument for service, call the Agilent Technologies Instrument Support Center at (800) 403-0801, visit the Test and Measurement Web Sites by Country page at <http://www.tm.agilent.com/tmo/country/English/index.html>, or call one of the numbers listed below.

Agilent Technologies Service Numbers

Austria	01/25125-7171
Belgium	32-2-778.37.71
Brazil	(11) 7297-8600
China	86 10 6261 3819
Denmark	45 99 12 88
Finland	358-10-855-2360
France	01.69.82.66.66
Germany	0180/524-6330
India	080-34 35788
Italy	+39 02 9212 2701
Ireland	01 615 8222
Japan	(81)-426-56-7832
Korea	82/2-3770-0419
Mexico	(5) 258-4826
Netherlands	020-547 6463
Norway	22 73 57 59
Russia	+7-095-797-3930
Spain	(34/91) 631 1213
Sweden	08-5064 8700
Switzerland	(01) 735 7200
United Kingdom	01 344 366666
United States and Canada	(800) 403-0801

- Step 1. Inspect the shipment 2-3
- Step 2. Check the fuse 2-4
- Step 3. Connect the line-power cable 2-5
- Step 4. Turn on the lightwave switch 2-7
- Step 5. Performing an operational check 2-8
- If The Operational Check Fails 2-10

Installing

WARNING

Before installing the lightwave switch, See “General Safety Considerations” on page iii of this manual.

CAUTION

OPTION 3XX INSTRUMENTS: To avoid damage, handle the pigtail fiber with care. Use only an appropriate fiber cleaver tool for cutting the fiber. Do not pull the bare fiber out of its jacket, crush it, kink it, or bend it past its minimum bend radius.

Install the instrument so that the front panel ON/OFF switch is readily identifiable and is easily reached by the operator. The ON/OFF switch, or the detachable power cord, is the instrument disconnecting device. It disconnects the mains circuit from the mains supply after the EMC filters and before other parts of the instrument. Alternatively, an external installed switch or circuit breaker (which is easily identifiable and is easily reached by the operator) may be used as a disconnecting device.

Install the instrument according to the enclosure protection provided. This instrument does *not* protect against the ingress of water. This instrument does protect against finger access to hazardous parts within the enclosure.

Step 1. Inspect the shipment

- 1** Verify that all components ordered have arrived by comparing the shipping forms to the original purchase order. Inspect all shipping containers.

If your shipment is damaged or incomplete, save the packing materials and notify both the shipping carrier and the nearest Agilent Technologies service office. Agilent Technologies will arrange for repair or replacement of damaged or incomplete shipments without waiting for a settlement from the transportation company. Notify the Agilent Technologies customer engineer of any problems.

- 2** Make sure that the serial number and options listed on the instrument's rear-panel label match the serial number and options listed on the shipping document.

Step 2. Check the fuse

- 1 Locate the line-input connector on the instrument's rear panel.
- 2 Disconnect the line-power cable if it is connected.
- 3 Use a small flat-blade screwdriver to open the pull-out line fuse drawer.

WARNING

For continued protection against fire hazard, replace line fuse only with same type and ratings (2A/250V). The use of other fuses or materials is prohibited.

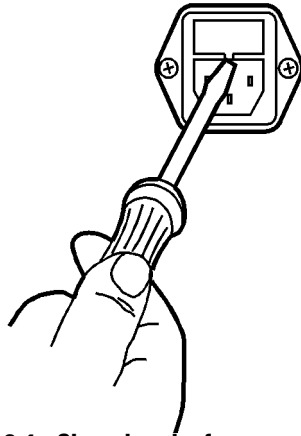

fusedr

Figure 2-1. Changing the fuse

- 4 Verify that the value of the line fuse in the pull-out drawer is correct.
115V operation, 5×20 mm, 2A, 250 V, fast acting UL/CSA fuse: . . .2110-0702
230V operation, 5×20 mm, 2A, 250 V, fast acting IEC fuse:2110-0702

Step 3. Connect the line-power cable

- 1 Verify that the line power meets the requirements shown in the following table.

Table 2-1. Agilent 86060C-Series Power Requirements





Characteristic	Requirement
<i>Input Voltage</i>	<i>within range 90 to 254 Vac</i>
<i>Frequency</i>	<i>within range 47 to 63 Hz</i>
<i>Power</i>	<i>80 VA (maximum)</i>

- 2 Connect the line-power cord to the instrument's rear-panel connector.
- 3 Connect the other end of the line-power cord to the power receptacle.

The lightwave switch is equipped with a three-wire power cable, in accordance with international safety standards. When connected to an appropriate power line outlet, this cable grounds the instrument cabinet.

Various power cables are available to connect the lightwave switch to the types of ac power outlets unique to specific geographic areas. The cable appropriate for the area to which the lightwave switch is originally shipped is included with the unit. You can order additional ac power cables for use in different areas. [“Power Cords” on page 2-6](#) lists the available ac power cables, illustrates the plug configurations, and identifies the geographic area in which each cable is appropriate.

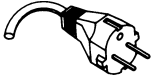
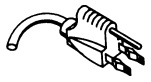
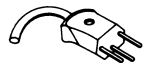
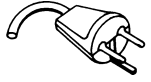
Power Cords

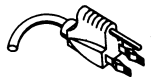
Plug Type	Cable Part No.	Plug Description	Length (in/cm)	Color	Country
250V 	8120-1351 8120-1703	Straight *BS1363A 90°	90/228 90/228	Gray Mint Gray	United Kingdom, Cyprus, Nigeria, Zimbabwe, Singapore
250V 	8120-1369 8120-0696	Straight *NZSS198/ASC 90°	79/200 87/221	Gray Mint Gray	Australia, New Zealand
250V 	8120-1689 8120-1692 8120-2857p	Straight *CEE7-Y11 90° Straight (Shielded)	79/200 79/200 79/200	Mint Gray Mint Gray Coco Brown	East and West Europe, Saudi Arabia, So. Africa, India (unpolarized in many nations)
125V 	8120-1378 8120-1521 8120-1992	Straight *NEMA5-15P 90° Straight (Medical) UL544	90/228 90/228 96/244	Jade Gray Jade Gray Black	United States, Canada, Mexico, Philippines, Taiwan
250V 	8120-2104 8120-2296	Straight *SEV1011 1959-24507 Type 12 90°	79/200 79/200	Mint Gray Mint Gray	Switzerland
220V 	8120-2956 8120-2957	Straight *DHCK107 90°	79/200 79/200	Mint Gray Mint Gray	Denmark
250V 	8120-4211 8120-4600	Straight SABS164 90°	79/200 79/200	Jade Gray	Republic of South Africa India
100V 	8120-4753 8120-4754	Straight MITI 90°	90/230 90/230	Dark Gray	Japan

* Part number shown for plug is the industry identifier for the plug only. Number shown for cable is the Agilent Technologies part number for the complete cable including the plug.

Step 4. Turn on the lightwave switch

- 1 Turn the lightwave switch on by pressing the line switch. The liquid-crystal display (LCD) displays the message:

Initializing

Screen Saver
A screen-saver has been built in to the switch to prolong the lifetime of the backlit LCD. The screen-saver turns off the LCD backlighting after 10 minutes elapses without a front-panel key being pressed. The time interval is not adjustable. To resume operation, press any key.

When the switch is turned on, it automatically resets to channel 0 (reset, optical off position).

Step 5. Performing an operational check

CAUTION

Improper connector care, cleaning, or use of mismatched cable connectors can invalidate the published specifications and damage connectors. Clean all cables before applying to any connector. Repair of damaged connectors due to improper use is not covered under warranty. Refer to [“Cleaning Connections for Accurate Measurements”](#) on page 1-12 for proper cleaning procedures.

Return loss

Return loss can be tested using a number of different test equipment configurations. Some of these are:

- an Agilent 8703A lightwave component analyzer
- an Agilent 8702B lightwave component analyzer with the appropriate source, receiver and lightwave coupler
- an Agilent 8504B precision reflectometer
- an Agilent 8153A lightwave multimeter and Agilent 81534A return loss module

Many other possibilities exist. The basic requirements are an appropriate lightwave source, a compatible lightwave receiver, and a compatible lightwave coupler.

Refer to the manuals provided with your lightwave test equipment for information on how to perform a return loss test.

Typical return loss is better than 40 dB. For actual specifications on your particular cable or accessory, refer to the manufacturer.

Insertion loss

Insertion loss can be tested using a number of different test equipment configurations. Some of these are:

- an Agilent 8702B or Agilent 8703A lightwave component analyzer system with a lightwave source and receivers
- an Agilent 83420 lightwave test set with an Agilent 8510 network analyzer
- an Agilent 8153A lightwave multimeter with a source and a power sensor module

Step 5. Performing an operational check

Many other possibilities exist. The basic requirements are an appropriate lightwave source and a compatible lightwave receiver. Refer to the manuals provided with your lightwave test equipment for information on how to perform an insertion loss test.

Typical insertion loss for cables is less than 1 dB, and can be as little as 0.1 dB. For actual specifications on your particular cable or accessory, refer to the manufacturer.

If The Operational Check Fails

If the Agilent 86060C does not pass the operational check, you should review the procedure being performed when the problem occurred. A few minutes spent performing some simple checks may save waiting for your instrument to be repaired. Before calling Agilent Technologies or returning the unit for service, please make the following checks:

- 1** Is the line fuse good?
- 2** Does the line socket have power?
- 3** Is the unit plugged in to the proper ac power source?
- 4** Is the unit turned on?
- 5** If other equipment, cables, and connectors are being used with the lightwave switch, are they connected properly and operating correctly?
- 6** Review the procedure for the test being performed when the problem appeared. Are all the settings correct?
- 7** Are the connectors clean? Refer to [“Cleaning Connections for Accurate Measurements”](#) on page 1-12 for more information about cleaning the connectors.

Refer to [“Spare Channel Replacement Procedure”](#) on page 5-4 for more information.

If the Agilent 86060C lightwave switch still fails, return it to Agilent Technologies for repair; if the lightwave switch is still under warranty or is covered by an Agilent Technologies maintenance contract, it will be repaired under the terms of the warranty or contract (the warranty is at the front of this manual). If the lightwave switch is no longer under warranty or is not covered by an Agilent Technologies maintenance plan, Agilent Technologies will notify you of the cost of the repair after examining the unit. Refer to [“Returning the Instrument for Service”](#) on page 1-22 for more information.

Front-Panel Features	3-3
Rear-Panel Features	3-5
Changing Switch Position	3-6
Adjusting Display Contrast	3-7
Saving Switch States	3-7

Using the Switch

Using the Switch

This chapter describes the front and rear-panel features. It also provides step-by-step procedures for configuring the lightwave switch. Position the lightwave switch according to the enclosure protection provide. This instrument does not protect against the ingress of water. This instrument protects against finger access to hazardous parts within the enclosure.

WARNING

To prevent electrical shock, disconnect the Agilent 86060C-series switch from the mains before cleaning. Use a dry cloth or one slightly dampened with water to clean the external case parts. Do not attempt to clean internally.

WARNING

On Option 002 dual input instruments, any light on an unselected “A” channel will likely be output on one of the unselected “B” channels.

On Option 002 dual input instruments, any light on an unselected “B” channel will likely be output on an unselected “A” channel.

To avoid exposure to light energy, always cover all unused channels.

Front-Panel Features

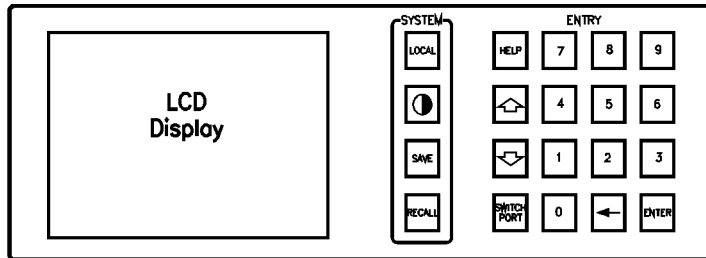

frontpnl

Figure 3-1. The Agilent 86060C-series front-panel functional area

Screen Saver

A screen-saver has been built in to the switch to prolong the lifetime of the backlit LCD. The screen-saver turns off the LCD backlighting after 10 minutes elapses without a front-panel key being pressed. The time interval is not adjustable. To resume operation, press any key.

LINE **Switch**

Turns the lightwave switch on and off. The front-panel LINE switch disconnects the mains circuits from the mains supply after the EMC filters and before other parts of the instrument.

Display

Graphically shows current signal path of the switch and the current GPIB status of the RMT, LSN, TLK, and SRQ lines.



key

Use this key to adjust the contrast of the display.

HELP **key**

Press to use built-in Help. Then press any of the front-panel keys. A short explanation of that key's function will be displayed.

Front-Panel Features

- LOCAL key** Press this key to display the GPIB address of the lightwave switch. You can also change the address using the numeric keypad. If a computer has placed the instrument in remote control, is this key to reenable front-panel control.
- SAVE & RECALL keys** Use these keys to save and recall switch configurations. Ten internal memory registers, selected using the numeric keypad, are available.
- SWITCH PORT key** Repeatedly pressing this key activates either “A” or “B” channels. Once activated, use the arrow keys to select the active switch port.

Rear-Panel Features

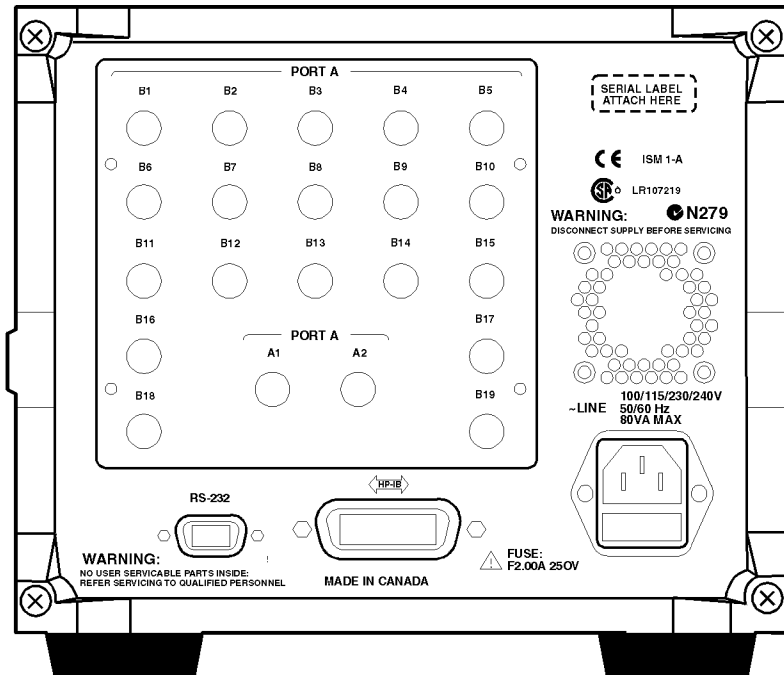

Figure 3-2. The Agilent 86060C-series rear-panel functional area

Optical connector(s)

The number of optical connectors depends on the Agilent 86060C-series switch. The connectors are grouped as Port A and Port B.

GPIB connector

Provides for remote control of the lightwave switch via the GPIB interface bus. Refer to “Programming over GPIB” on page 4-6.

RS-232 connector

Provides for remote control of the lightwave switch via RS-232. Refer to “Programming over RS-232” on page 4-8.

Changing Switch Position

To set single port A switches

The $1 \times N$ switch has a single Port A channel and multiple Port B channels.

- 1** To select a Port B channel, press: SWITCH PORT

The Port B channels are shown in inverse video and the prompt, Port B active, appears at the bottom of the display.

- 2** Use the arrow keys to change the Port B channel.

You can also use the numeric keys to enter the desired Port B channel. For example: 4 followed by ENTER.

The new connection is displayed on the front-panel display.

To set dual port A switches

The $2 \times N$ switch has two Port A channels and multiple Port B channels.

- 1** To select the Port A channel, press: SWITCH PORT

The Port A channels are shown in inverse video and the prompt, Port A active, appears at the bottom of the display.

- 2** To select a Port B channel, again press: SWITCH PORT

The Port B channels are shown in inverse video and the prompt, Port B active, appears at the bottom of the display.

- 3** Use the arrow keys to change the channel.

You can also use the numeric keys to enter the desired channel. For example: 4 followed by ENTER.

The new connection is displayed on the front-panel display.

Adjusting Display Contrast

To adjust the contrast of the display, press the  key. Use the arrow keys to select the desired contrast, then press ENTER.

Saving Switch States

To save a state

To save the currently displayed switch state in one of the ten internal storage registers, press **SAVE**, and then press one of the numeric keys (0–9).

To recall a state

To recall a previously saved switch state from one of the ten internal storage registers, press **RECALL**, and then press one of the numeric keys (0–9).

General Information	4-3
Programming over GPIB	4-6
Programming over RS-232	4-8
Common Commands	4-11
Standard SCPI Commands	4-22
Instrument Specific Commands	4-26
Error Messages	4-30
Programming Examples	4-31

Programming

The programming instructions in this manual conform to the IEEE 488.2 Standard Digital Interface for Programmable Instrumentation and to the Standard Commands for Programmable Instruments (SCPI). The programming instructions provide the means of remote control.

Where to begin . . .

- To program the Agilent 86060C-series lightwave switch, it is necessary to add either a GPIB or RS-232 interface to the rear panel of the switch.
- The programming examples for individual commands in this manual are written in HP¹ BASIC 6.0 for an HP 9000 Series 200/300 Controller.
- For more information regarding the GPIB, the IEEE 488.2 standard, or the SCPI standard, refer to the following books:

Hewlett-Packard Company. *Tutorial Description of Hewlett-Packard Interface Bus*, 1987.

Hewlett-Packard Company. *SCPI—Standard Commands for Programmable Instruments*, 1991.

International Institute of Electrical and Electronics Engineers. *IEEE Standard 488.1-1987, IEEE Standard Digital Interface for Programmable Instrumentation*. New York, NY, 1987.

International Institute of Electrical and Electronics Engineers. *IEEE Standard 488.2-1987, IEEE Standard Codes, Formats, Protocols and Common commands For Use with ANSI/IEEE Std 488.1-1987*. New York, NY, 1987.

1. Hewlett-Packard and HP are registered trademarks of Hewlett-Packard Company.

General Information

This instrument has three types of commands:

- Common commands
- Standard SCPI commands
- Instrument specific commands

Common commands

The common commands are the commands defined by IEEE 488.2. These commands control some functions that are common to all IEEE 488.2 instruments. Common command headers consist of only a single mnemonic preceded by an asterisk.

Example: *RST

Standard SCPI commands

The standard SCPI commands are the STATUS subsystem commands required for compatibility with SCPI. In most instruments, the STATUS subsystem commands are used to report device-dependent errors. In the lightwave switch, these commands have no function but are included for SCPI compatibility. Standard SCPI command headers are compound headers consisting of two or more mnemonics.

Example: :STATUS:OPERATION:ENABLE

Instrument specific commands

Instrument specific commands are those commands which are specific to the control of the switch. These commands control switch movements and report the configuration of the switch. Instrument specific commands are compound headers consisting of two or more mnemonics.

Example: :ROUTE:LAYER:CHANNEL

Setting the switches

Use the [:ROUte]:[LAYer]:CHANnel command to set the channel connections for a particular switch layer. A layer is a particular switch matrix that creates a path from an “A” port to a “B” port. When the lightwave switch has multiple

General Information

switch layers, the switch layers are referred to by the word LAYER in the ROUTE:LAYER:CHANNEL command. The numeric value at the end of the mnemonic LAYER selects the switch block to which the ROUTE:LAYER:CHANNEL command should be applied. For example, in the following program statement, the command is applied to switch layer 2 of the instrument.

```
OUTPUT 711,":ROUTE:LAYER2:CHANNEL A2,B4"
```

The following HP BASIC statement command moves the switch on switch layer 1 to channel 1 of port A and channel 1 of port B:

```
OUTPUT 711,":ROUTE:LAYER1:CHANNEL A1,B1"
```

This next example sets port A to channel 2 and port B to channel 5:

```
OUTPUT 711,":ROUTE:LAYER1:CHANNEL A2,B5"
```

To learn more about this command, refer to “[:ROUTE]:[LAYER]:CHANnel” on [page 4-27](#).

The current switch setting can be queried. The query :ROUTE:LAYER1:CHANNEL? places the current channel setting on layer 1 in the output queue. In HP BASIC, the controller input statement:

```
ENTER <device address>;Setting$
```

passes the value across the bus to the controller and places it in the variable Setting\$.

Returning the switch to manual control

To return the switch to manual control after remote operation, press LOCAL.

Response generation

As defined by IEEE 488.2, query responses may be buffered for the following conditions:

- When the query is parsed by the instrument.
- When the controller addresses the instrument to talk so that it may read the response.

The responses to a query are buffered when the query is parsed.

Command headers immediately followed by a question mark (?) are queries. Query commands are used to find out information regarding the instrument's current state. After receiving a query, the instrument interrogates the requested function and places the answer in its output queue. The answer remains in the output queue until it is read or another command is issued. When read, the answer is transmitted across the bus to the designated listener (typically a controller).

The output queue must be read before the next program message is sent. For example, when you send the query `:SYSTEM:CONFIG?` you must follow that query with an input statement. In HP BASIC, this is usually done with an `ENTER` statement immediately followed by a variable name. This statement reads the result of the query and places the result in a specified variable.

Programming over GPIB

This section describes the GPIB interface functions and some general concepts. In general, these functions are defined by IEEE 488.2. They deal with general interface management issues, as well as messages which can be sent as interface commands.

Default address The GPIB address is factory preset to 711. To change the GPIB address, press LOCAL. The last two digits of the current GPIB address are displayed. To enter a different address, press the two numeric keys for that address. For example: 14 for address 714, then press ENTER.

Command and data concepts The interface has two modes of operation:

- command mode
- data mode

The bus is in the data mode when the ATN line is false. The data mode is used to convey device-dependent messages across the bus.

Addressing The address is used to determine which instrument on the interface bus with which the controller is communicating.

- Each device on the GPIB resides at a particular address, 0–30.
- The active controller specifies which devices talk and which listen.
- An instrument may be talk addressed, listen addressed, or unaddressed by the controller.

If the controller addresses the instrument to talk, the instrument remains configured to talk until it receives an interface clear message (IFC), another instrument's talk address (OTA), its own listen address (MLA), or a universal untalk command (UNT).

If the controller addresses the instrument to listen, the instrument remains configured to listen until it receives an interface clear message (IFC), its own talk address (MTA), or a universal unlisten command (UNL).

Interface select code (selects interface)

Each interface card has a unique interface select code. This code is used by the controller to direct commands and communications to the proper interface. The default is typically "7" for GPIB controllers.

Instrument address (selects instrument)

Each instrument on an GPIB must have a unique instrument address between decimal 0 and 30. The device address passed with the program message must include not only the correct instrument address, but also the correct interface select code.

$$\text{DEVICE ADDRESS} = (\text{Interface Select Code} * 100) + (\text{Instrument Address})$$

For example, if the instrument address for the instrument is 4 and the interface select code is 7, when the program message is passed, the routine performs its function on the instrument at device address 704.

For this instrument, the address is typically set to "11" at the factory. This address can be changed by pressing the LOCAL key on the front panel.

NOTE

The examples in this manual assume the instrument is at device address 711.

Lockout

With GPIB, the instrument is placed in the lockout mode by sending the local lockout command (LLO). The instrument can be returned to local by sending the go-to-local command (GTL) to the instrument.

NOTE

Cycling the power also restores front panel control.

Bus commands

The following commands are IEEE 488.1 bus commands (ATN true). IEEE 488.2 defines many of the actions which are taken when these commands are received by the instrument.

The device clear (DCL) or selected device clear (SDC) commands clear the input and output buffers, reset the parser, and clear any pending commands.

The interface clear (IFC) command halts all bus activity. This includes unaddressing all listeners and the talker, disabling serial poll on all devices, and returning control to the system controller.

Programming over RS-232

This section describes the interface functions and some general concepts of the RS-232 interface. The RS-232 interface on this instrument is Hewlett-Packard's implementation of EIA Recommended Standard RS-232, "Interface Between Data Terminal Equipment and Data Communications Equipment Employing Serial Binary Data Interchange." With this interface, data is sent one bit at a time and characters are not synchronized with preceding or subsequent data characters. Each character is sent as a complete entity without relationship to other events.

NOTE

IEEE 488.2 is designed to work with IEEE 488.1 as the physical interface. When RS-232 is used as the physical interface, as much of IEEE 488.2 is retained as the hardware differences will allow. No IEEE 488.1 messages such as DCL, GET, and END are available.

Interface operation

The switch can be programmed with a controller over RS-232 using an interface cable that is appropriate for your application. The operation and exact connections for this interface are described in more detail in the following sections. When you are using a controller to program a switch over RS-232, you are normally operating directly between two DTE (Data Terminal Equipment) devices as compared to operating between a DTE device and a DCE (Data Communications Device) device.

Cables

The type of RS-232 cable you use to connect the controller to the switch will depend on your application. The following paragraphs describe which lines of the switch are used to control the operation of the RS-232 bus relative to the switch. To locate the proper cable for your application, refer to the reference manual for your controller.

3-wire interface

The switch uses a 3-wire RS-232 interface. It provides a simple connection between devices because you can ignore hardware handshake requirements. The switch uses the following connections on its RS-232 interface for 3-wire communication:

	Switch	Computer
SGND (Signal Ground)	Pin 5	Pin 5
TD (Transmit Data from switch)	Pin 2	Pin 2
RD (Receive Data into switch)	Pin 3	Pin 3

The TD (Transmit Data) line from the switch must connect to the RD (Receive Data) line on the controller. Likewise, the RD line from the switch must connect to the TD line on the controller. The RS-232 interface on the switch ignores all signals on the DCD, DSR, RTS, and CTS lines.

NOTE

If the instrument is used with QBASIC programming language, pin 6, 7, and 8 of the DTE connector should be shorted together.

Interface settings

The baud rate, stop bits, parity, protocol, and data bits must be configured exactly the same for both the controller and the switch to properly communicate over the RS-232 interface. The RS-232 interface capabilities of the light-wave switch are listed below:

Baud Rate	1200 or 9600
Parity	None
Data Bits	8
Stop Bits	1

The baud rate is factory set to 9600 baud. To change the baud rate, press the LOCAL key twice. The current baud rate is displayed. Use the arrow keys to change the baud rate to 1200 or 9600. When the desired rate is displayed, press ENTER.

Data bits

Data bits are the number of bits sent and received per character that represent the binary code of that character.

Information is stored in bytes (8 bits at a time) in the switch. Data can be sent and received just as it is stored, without the need to convert the data.

Communicating over the RS-232 interface

Each RS-232 interface card has its own interface select code. This code is used by the controller to direct commands and communications to the proper interface. Unlike GPIB, which allows multiple devices to be connected through a single interface card, RS-232 is only connected between two devices at a time through the same interface card. Because of this, only the interface code is required for the device address.

Generally, the interface select code can be any decimal value between 0 and 31, except for those interface codes which are reserved by the controller for internal peripherals and other internal interfaces. This value can be selected through switches on the interface card. For more information, refer to the reference manual for your interface card or controller.

RS-232 commands

RS-232 control of the switch is initiated by sending the OPEN RS232 COM command over the interface. This places the switch in the remote mode and locks out the front panel. Pressing the LOCAL key will bring the instrument back to local mode.

Many of the commands used for controlling the switch and for retrieving data from the switch are the same as for the GPIB interface. Refer to the individual command descriptions to determine if the command applies to both GPIB and RS-232.

To end communications with the switch over the RS-232 interface, send the CLOSE RS232 COM command. This command returns control to the front panel of the instrument.

Common Commands

The following commands are required by the IEEE 488.2–1987 standard.

*CLS (Clear Status)

The *CLS (clear status) common command clears all the event registers summarized in the Status Byte register. With the exception of the output queue, all queues that are summarized in the Status Byte Register are emptied. The error queue is also emptied. Neither the Standard Event Status Enable Register, nor the Service Request Enable Register are affected by this command.

After the *CLS command, the instrument is left in the idle state. The command does not alter the instrument setting. *OPC/*OPC? actions are cancelled.

Usage: GPIB only

Command Syntax: *CLS

Example: OUTPUT 711; "*CLS"

*ESE (Event Status Enable)

The *ESE command sets the bits in the Standard Event Status Enable Register and enables the corresponding bits in the Standard Event Status Register. The Standard Event Status Enable Register contains a mask value for the bits to be enabled in the Standard Event Status Register. A bit set to one in the Standard Event Status Enable Register enables the corresponding bit in the Standard Event Status Register. A zero disables the bit. Refer to [Table 4-1](#) for information about the Standard Event Status Enable Register bits, bit weights, and what each bit masks.

***ESE (Event Status Enable)**

The Standard Event Status Enable Register is cleared at power-on. The *RST and *CLS commands do not change the register.

The *ESE query returns the value of the Standard Event Status Enable Register.

Usage: GPIB only

Command Syntax: *ESE <mask>

Where: <mask> ::= 0 to 255

Example: OUTPUT 711; "*ESE 64"

In this example, the *ESE 64 command enables URQ (user request) bit 6 of the Standard Event Status Enable Register. Therefore, when a front-panel key is pressed, the ESB (event summary bit) in the Status Byte Register is also set.

Query Syntax: *ESE?

Returned Format: <mask><NL>

Where: <mask> ::= 0 to 255 (integer-NR1 format)

Table 4-1. Standard Event Status Enable Register

(High-Enables the ERS bit)		
Bit	Bit Weight	Enables
7	128	PON – Power On
6	64	URQ – User Request
5	32	CME – Command Error
4	16	EXE – Execution Error
3	8	NOT USED
2	4	OYE – Query Error

Table 4-1. Standard Event Status Enable Register

(High—Enables the ERS bit)		
Bit	Bit Weight	Enables
1	2	NOT USED
0	1	OPC – Operation Complete

***ESR (Event Status Register)**

The *ESR query returns the value of the Standard Event Status Register.

When you read the Event Status Register, the value returned is the total of the bit weights of all of the bits that are set to one at the time you read the byte. [Table 4-2](#) shows each bit in the Event Status Register and its bit weight.

Reading the register clears the Event Status Register.

- Usage:** GPIB only
- Query Syntax:** *ESR?
- Returned Format:** <status><NL>
- Where:** <status> ::= 0 to 255 (integer–NR1 format)
- Example:**
- ```
OUTPUT 711; "*ESR?"
ENTER 711; Event
PRINT Event
```

**Table 4-2. Standard Event Status Register**

| <b>Bit</b> | <b>Bit Weight</b> | <b>Condition</b>    |
|------------|-------------------|---------------------|
| 7          | 128               | PON – Power On      |
| 6          | 64                | URQ – User Request  |
| 5          | 32                | CME – Command Error |

**\*IDN (Identification Number)****Table 4-2. Standard Event Status Register**

| Bit | Bit Weight | Condition                |
|-----|------------|--------------------------|
| 4   | 16         | EXE – Execution Error    |
| 3   | 8          | NOT USED                 |
| 2   | 4          | QYE – Query Error        |
| 1   | 2          | NOT USED                 |
| 0   | 1          | OPC – Operation Complete |

**\*IDN (Identification Number)**

The \*IDN query returns a string value which identifies the instrument type and firmware version.

An \*IDN query must be the last query in a program message. Any queries after the \*IDN query in a program message are ignored.

**Usage:** GPIB and RS-232

**Query Syntax:** \*IDN?

**Returned Format:** "HEWLETT-PACKARD 8606XC, 0, VERSION <X.X>"

**Where:** <X.X> = firmware revision number  
8606XC is the model number and can be 86060C, 86061C, or 86062C.

**Example:**

```
DIM Id$ [50]
OUTPUT 711;"*IDN?"
ENTER 711;Id$
PRINT Id$
```



---

## \*OPC (Operation Complete)

The \*OPC command sets the operation complete bit in the Standard Event Status Register when all pending device operations have finished.

The \*OPC query places an ASCII "1" in the output queue when all pending device operations have finished.

### NOTE

The \*OPC command can be used to ensure all switch movement operations have completed before continuing the program. By following a ROUTE:LAYER:CHANNEL command with an \*OPC query and an ENTER statement, the program will pause until the response (ASCII "1") is returned by the instrument.

**Usage:** GPIB only

**Command Syntax:** \*OPC

**Example:** OUTPUT 711;"\*OPC"

**Query Syntax:** \*OPC?

**Returned Format:** 1<NL>

**Example:** OUTPUT 711;"\*OPC?"  
ENTER 711;Op\$

---

## \*RCL (Recall)

The \*RCL command recalls the state of the instrument from the specified instrument state register. If the instrument state register has not been previously stored, the \*RCL command will restore the instrument to its power-on state.

**Usage:** GPIB and RS-232

**\*RST (Reset)**

**Command Syntax:** \*RCL <value>

**Where:** <value> ::= 0 to 9 (integer-NR1 format)

**Example:** OUTPUT 711; "\*RCL 3"

---

**\*RST (Reset)**

The \*RST command returns the switch to its power-up condition. For all layers, each port is set to its OFF position or channel 1.

**Usage:** GPIB and RS-232

**Command Syntax:** \*RST

**Example:** OUTPUT 711; "\*RST"

---

**\*SAV (Save)**

The \*SAV command saves the current state of the instrument to the specified instrument state register.

**Usage:** GPIB and RS-232

**Command Syntax:** \*SAV <value>

**Where:** <value> ::= 0 to 9 (integer-NR1 format)

**Example:** OUTPUT 711; "\*SAV 3"

---

## **\*SRE (Service Request Enable)**

The \*SRE command sets the bits in the Service Request Enable Register. The Service Request Enable Register contains a mask value for the bits to be enabled in the Status Byte Register. A bit set to one (1) in the Service Request Enable Register enables the corresponding bit in the Status Byte Register. A zero (0) disables the bit. [Table 4-3](#) lists the bits in the Service Request Enable Register and what they mask.

The Service Request Enable Register is cleared at power-on. The \*RST and \*CLS commands do not change the register.

The \*SRE query returns the value of the Service Request Enable Register.

**Usage:** GPIB only

**Command Syntax:** \*SRE <mask>

**Where:** <mask> ::= 0 to 255

**Example:** OUTPUT 711; "\*SRE 32"

In this example, the \*SRE 32 command enables ESB (event summary) bit 5 of the Status Byte Register, the MSS (master summary status) bit 6 in the Status Byte Register is also set.

**Query Syntax:** \*SRE?

**Returned Format:** <mask><NL>

**Where:** <value> ::= 0 to 255 (integer-NR1 format)

**Table 4-3. Service Request Enable Register**

---

| <b>Service Request Enable Register<br/>(High—Enables the SRE bit)</b> |                   |                             |
|-----------------------------------------------------------------------|-------------------|-----------------------------|
| <b>Bit</b>                                                            | <b>Bit Weight</b> | <b>Enables</b>              |
| 7                                                                     | 128               | Not Used                    |
| 6                                                                     | 64                | MSS – Master Summary Status |
| 5                                                                     | 32                | ESB – Event Status Bit      |
| 4                                                                     | 16                | MAV – Message Available     |
| 3                                                                     | 8                 | Not Used                    |
| 2                                                                     | 4                 | Not Used                    |
| 1                                                                     | 2                 | Not Used                    |
| 0                                                                     | 1                 | OPP – Operation Pending     |

---

---

## \*STB (Status Byte)

The \*STB query returns the current value of the instrument's status byte. The MSS (Master Summary Status) bit 6 indicates whether or not the device has at least one reason for requesting service.

When you read the Status Byte Register, the value returned is the total of the bit weights of all the bits set to one (1) at the time you read the byte. [Table 4-4](#) shows each bit in the Status Byte Register and its bit weight.

The \*STB query does not affect the contents of the Status Byte Register.

### NOTE

To read the instrument's status byte with RQS reported on bit 6, use the interface Serial Poll.

### NOTE

The \*STB query can be used to determine when the switch has settled to a new position. After sending a :ROUTE:LAYER:CHANNEL command, bit 0 of the Status Byte Register will be set to one while the switch is moving and return to zero when the switch has settled.

- Usage:** GPIB only
- Query Syntax:** \*STB?
- Returned Format:** <value><NL>
- Where:** <value> ::= 0 to 255 (integer – NR1 format)
- Example:**
- ```
OUTPUT 711;"*STB?"
ENTER 711;Value
PRINT Value
```

Table 4-4. Status Byte Register

Bit	Bit Weight	Condition
7	128	Not Used
6	64	MSS – Master Summary Status
5	32	ESB – Event Status Bit
4	16	MAV – Message Available
3	8	Not Used
2	4	Not Used
1	2	Not Used
0	1	OPP – Operation Pending

***TST (Test)**

The *TST query performs a self-test on the instrument. The result of the test is placed in the output queue. A zero indicates the test passed and a non-zero value indicates the test failed. If a test fails, [refer to “Step 5. Performing an operational check” on page 2-8.](#)

Usage: GPIB and RS-232

Query Syntax: *TST?

Returned Format: <result><NL>

Where: <result> ::= 0 or non-zero value
0 indicates the test passed.
non-zero indicates the test failed.

Example:

```
OUTPUT 711; "*TST?"
ENTER 711; Result
PRINT Result
```

***WAI (Wait)**

The *WAI command prevents the instrument from executing any further commands until the current command has finished executing. All pending operations are completed during the wait period.

NOTE

The *WAI command can be used to ensure all switch movement operations have completed before continuing the program. Following a ROUTE:LAYER:CHANNEL command with a *WAI command followed by a query, will ensure the query is not answered until the switch has settled to its new position.

Usage: GPIB only

Command Syntax: *WAI

Example:

```
OUTPUT 711;":ROUTE:LAYER1:CHANNEL A2,B4"  
OUTPUT 711;"*WAI"  
OUTPUT 711;"SYSTEM:CONFIG?"  
ENTER 711;DUMMY$
```

Standard SCPI Commands

:STATus:<node>:CONDition

The :STATus:<node>:CONDition query returns the value for the condition register for the node. Condition registers have no function in this instrument, but the query is included for compatability with the SCPI standard. This query always returns the value 0.

Usage: GPIB only

Query Syntax: :STATus:<node>:CONDition?

Returned Format: <value>

Where: <value> = 0 (integer – NR1)
<node> = OPERation | QUEStionable

Example: OUTPUT 711; ":STATUS:OPERATION:CONDITION?"
ENTER 711;Value
PRINT Value

:STATus:<node>:ENABLE

The :STATus:<node>:ENABLE command sets the enable register for the node. Enable registers have no function in this instrument, but the command is included for compatability with the SCPI standard.

The :STATus:<node>:ENABLE query returns the value of the enable register for the node.

Usage: GPIB only

Command Syntax: :STATus:<node>:ENABLE<value>

Where: <node> = OPERation | QUEStionable
<value> ::= 0 to 32767 (integer or floating point – NR1)

Example: OUTPUT 711;" :STATUS:QUESTIONABLE:ENABLE 1024"

Query Syntax: :STATus:<node>:ENABLE?

Returned Format: <value>

Where: <node> = OPERation | QUEStionable
<value> ::= 0 to 32767 (integer – NR1)

Example: OUTPUT 711;" :STATUS:QUESTIONABLE:ENABLE?"
ENTER 711;Value
PRINT Value

:STATus:<node>[:EVENT]

The :STATus:<node>[:EVENT] query returns the value of the event register for the node. Event registers have no function in this instrument, but the query is included for compatibility with the SCPI standard. This query always returns the value 0.

Usage: GPIB only

Query Syntax: :STATus:<node>[:EVENT?]

Returned Format: <value>

Where: <value> = 0 (integer – NR1)
<node> = OPERation | QUEStionable

Example: OUTPUT 711;" :STATUS:OPERATION:EVENT?"
ENTER 711;Value
PRINT Value

:STATus:PRESet

The :STATus:PRESet command presets the enable registers for all status nodes. Enable registers have no function in this instrument, but the command is included for compatibility with the SCPI standard. [Table 4-5](#) shows the value of each enable register.

- Usage:** GPIB only
- Query Syntax:** :STATus:PRESet
- Example:** OUTPUT 711 ; " : STATUS : PRESET "

Table 4-5. Values of the Enable Registers

Status Node	Preset Value
Operation	0
Questionable	0

:SYSTem:ERRor

The :SYSTem:ERRor query returns the next error number and error description in the error queue over the interface. This instrument has an error queue 100 errors deep and operates on a first-in, first-out basis. Repeatedly sending the query :SYSTEM:ERROR? returns the error numbers and descriptions in the order in which they occur until the queue is empty. Any further queries returns "+0,No errors" until another error occurs. Refer to [Table 4-6](#) for the error numbers and descriptions.

- Usage:** GPIB and RS-232
- Query Syntax:** :SYSTem:ERRor?
- Returned Format:** <value>, <string>

Where: <value> = an integer error code (NR1)
<string> = text of error message

Example: DIM Error\$ [50]
OUTPUT 711;":SYSTEM:ERROR?"
ENTER 711;Error\$
PRINT Error\$

Instrument Specific Commands

The following commands are specific to remote operation of the Agilent 86060C-series lightwave switches.

CLOSE RS232 COM

The CLOSE RS232 COM command disables remote operation of the instrument over the RS-232 interface and enables the front-panel keyboard. This command is the same as pressing the LOCAL key while in remote operation over the RS-232 interface.

Usage: RS-232 only

Command Syntax: CLOSE RS232 COM

Example:

```
com_port=9  
OUTPUT com_port; "CLOSE RS232 COM"
```

OPEN RS232 COM

The OPEN RS232 COM command enables remote operation of the instrument over the RS-232 interface and locks out the front-panel keyboard. This command must be sent before sending any other commands over the RS-232 interface. Press the LOCAL key to return to local mode and lock out the RS-232 interface.

Usage: RS-232 only

Command Syntax: OPEN RS232 COM

Example: com_port=9
 OUTPUT com_port; "OPEN RS232 COM"

[:ROUte]:[LAYer]:CHANnel

The [:ROUte]:[LAYer]:CHANnel command configures the channel connections. In the command syntax, the keyword “LAYer” refers to a switch layer. A switch layer is a switch matrix of “A” ports and “B” ports. Normal lightwave switches have only one layer installed. Special ordered instruments may have multiple switch layers installed. If the front and rear panels show more than one set of “A” ports and “B” ports, the instrument has multiple switch layers. Standard lightwave switches do not require that the <layer> argument be specified as shown in the command syntax. If no layer is specified, it defaults to layer 1. The minimum layer number is always 1.

The minimum channel number is either 0 or 1, depending on whether the port has an "OFF" position. The maximum number of layers and channels is dependent on the switch configuration. If the command parameters are outside the permitted range for the switch configuration, the switch position is not changed and an error is generated.

The [:ROUte]:[LAYer]:CHANnel query returns the current port settings for the specified layer. If no layer is specified, the default value is layer 1.

WARNING

On Option 002 dual input instruments, any light on an unselected “A” channel will likely be output on one of the unselected “B” channels.

On Option 002 dual input instruments, any light on an unselected “B” channel will likely be output on an unselected “A” channel.

To avoid exposure to light energy, always cover all unused channels.

Usage: GPIB and RS-232

Command Syntax: [:ROUte]:[LAYer<layer>]:CHANnel <channel_list>

Where: <layer> a positive integer (NR1). Set to 1 if the instrument does not have multiple layers.
 <channel list> = A<channel>|B<channel>|A<channel>|B<channel>
 <channel> = a non-negative integer (NR1) | OFF

:SYSTem:CONFig

Example: OUTPUT 711; ":ROUTE:LAYER2:CHANNEL A2,B78"
Connects A2 to B78 on layer 2

Query Syntax: [:ROUte]:[LAYer<layer>]:CHANnel?

Where: <layer> a positive integer (NR1)

Returned Format: A<channel>,B<channel>
<channel> = a non-negative integer (NR1)

Example: DIM Setting\$
OUTPUT 711; ":ROUTE:LAYER3:CHANNEL?"
ENTER 711;Setting\$
PRINT Setting\$

:SYSTem:CONFig

The :SYSTem:CONFig query returns the switch configuration of the instrument. For each layer, the minimum and maximum channel numbers for each port are given.

Usage: GPIB and RS-232

Query Syntax: :SYSTem:CONFig?

Returned Format: <config> = "L<i>A<j1>A<k1>B<l1>B<m1>A<j2>A<k2>B<l2>B<m2>..."

Where: <i> = number of layers on switch
 <j1> = minimum available channel on port A, layer 1
 <k1> = maximum available channel on port A, layer 1
 <l1> = minimum available channel on port B, layer 1
 <m1> = maximum available channel on port B, layer 1
 <j2> = minimum available channel on port A, layer 2
 <k2> = maximum available channel on port A, layer 2
 <l2> = minimum available channel on port B, layer 2
 <m2> = maximum available channel on port B, layer 2

Example:

```
DIM Config$  
OUTPUT 711;":SYSTem:CONFIG?"  
ENTER 711;Config$  
PRINT Config$
```

Error Messages

Table 4-6. Error Messages

Error Number	Description
-105	GET not allowed
-110	Command Header error
-120	Numeric Data error
-140	Character Data error
-150	String Data error
-170	Expression error
-220	Parameter error
-350	Too many errors
-410	Query INTERRUPTED
-420	Query UNTERMINATED
-430	Query DEADLOCKED
+300	Frame error
+310	Invalid command byte
+320	Invalid switch module byte
+330	Invalid data byte
+340	Packet checksum error
+4xx	Switch module xx not responding
+5xx	Switch module xx motor failed

Programming Examples

This section includes a number of programming examples to illustrate the use of remote commands in actual programs. These programming examples do not cover the full command set for the instrument. They are intended only as an introduction to the method of programming the instrument.

The example programs in this chapter are as follows:

- Example 1: This simple program uses the ROUTE:LAYER:CHANNEL command to move the switch to a new position. The program shows how to use the *WAI command to ensure that the switch has settled to its new position.
- Example 2: This program is similar to the first example program. Instead of using the *WAI command, the Status Byte Register is read repeatedly using the *STB query. When bit 0 of the Status Byte Register returns to zero, the switch has settled to its new position.
- Example 3: Repeating the same program as the first two examples, the *OPC command and *ESR query are now used to determine that the switch has settled to its new position. The *OPC command is sent before the :ROUTE:LAYER:CHANNEL command, and then the Standard Event Status Register is continuously read until bit 0 is set to one.
- Example 4: This example illustrates the use of two switches in an automated system to periodically monitor a number of devices under test (DUTs). The test system includes an Agilent 8153A optical multimeter with an Agilent 81554SM laser source and an Agilent 81532A optical power sensor. This program measures the optical power through each device under test every 5 minutes and displays a message if the power drops below 1 microwatt.

Example 1: Switch position using the *WAI command

This program prompts the operator for the desired switch position and then moves the switch to this position. The switch error queue is then read and printed. The program shows how to use the *WAI command to ensure that the switch has settled to its new position.

Listing

```
10  INTEGER Switch_addr,A_position,B_position
20  DIM Command$[80],Channel$[80],Error_return$[80],
    Dummy$[80]
30  Switch_addr=711
40  CLEAR SCREEN
50  INPUT "Enter A-port position : ",A_position
60  INPUT "Enter B-port position : ",B_position
70  Channel$="A"&TRIM$(VAL$(A_position))&","&B"&TRIM$
    (VAL$(B_position))
80  Command$="ROUTE:LAYER1:CHANNEL "&Channel$
90  OUTPUT Switch_addr;Command$
100 GOSUB Wait_to_settle
110 REPEAT
120     OUTPUT Switch_addr;"SYSTEM:ERROR?"
130     ENTER Switch_addr;Error_return$
140     PRINT Error_return$
150 UNTIL (VAL(Error_return$)=0)
170 GOTO Exit_prog
180 !
190 Wait_to_settle: ! wait for switch to settle
200 OUTPUT Switch_addr;"*WAI"
210 OUTPUT Switch_addr;"SYSTEM CONFIG?"
220 ENTER Switch_addr;Dummy$
230 RETURN
240 !
250 Exit_prog: !
260 END
```

Description

<u>Line No.</u>	<u>1</u>
10 to 20	Declare some variables for use in the program.
30	Set the Agilent 8606X Optical Switch address variable, Switch_addr, to 711 (factory default).
40 to 60	Clear the screen and prompt the operator for the desired switch position. Store the positions in variables A_position and B_position.
70	Set Channel\$ to represent the switch channel positions in

the form appropriate for the `ROUTE:LAYER:CHANNEL` GPIB command. For example, if `A_position=1` and `B_position=3`, then `Channel$` would equal `"A1, B3"`.

80 Set `Command$` to represent the full GPIB command to set the desired switch position, appending `Channel$`. For the example `Channel$` given above, `Command$` would equal `"ROUTE:LAYER1:CHANNEL A1, B3"`.

90 Send `Command$` to the Agilent 8606X Optical Switch via the GPIB interface.

100 Call the subroutine `wait_to_settle`.

110 to 150 These lines implement a `REPEAT-UNTIL` loop that continuously queries the Agilent 8606X for error status. The returned error message(s) are printed to the screen. This loop exits when the numeric value of the error string equals 0. This will occur when the error message `" +0, no error"` is returned.

170 Go to the end of the program.

190 to 230 The `wait_for_settle` subroutine.

200 Output the `*WAI` command to the Agilent 8606X Optical Switch. This command will prevent the switch from executing any further commands until the previous command (that is, the switch setting command) has completed. When the program continues after the completion of the command, the switches are guaranteed to have settled.

210 Output system configuration query to switch.

220 Read back switch configuration. Since this query was preceded by the `*WAI` command, the switch movement must be settled before the query is responded to.

230 Return execution to the line after call to subroutine (line 110).

Example 2: Switch position using the Status Byte Register

This program is identical in functionality to the first sample program except a different method is used for determining when the switch has settled. The settling routine used here reads the Status Byte Register repeatedly until bit 0 returns to zero.

Listing

```
10  INTEGER Switch_addr,A_position,B_position,
    Status_byte
20  DIM Command$[80],Channel$[80],Error_return$[80]
30  Switch_addr=711
40  CLEAR SCREEN
50  INPUT "Enter A-port position : ",A_position
60  INPUT "Enter B-port position : ",B_position
70  Channel$="A"&TRIM$(VAL$(A_position))&"B"&TRIM$(
    VAL$(B_position))
80  Command$="ROUTE:LAYER1:CHANNEL "&Channel$
90  OUTPUT Switch_addr;Command$
100 GOSUB Wait_to_settle
110 REPEAT
120     OUTPUT Switch_addr;"SYSTEM:ERROR?"
130     ENTER Switch_addr;Error_return$
140     PRINT Error_return$
150 UNTIL (VAL(Error_return$)=0)
170 GOTO Exit_prog
180 !
190 Wait_to_settle: ! wait for switch to settle
200 REPEAT
210     OUTPUT Switch_addr;"*STB?"
220     ENTER Switch_addr;Status_byte
230 UNTIL NOT BIT(Status_byte,0)
240 RETURN
250 !
260 Exit_prog:!
270 END
```

Description	<u>Line No.</u>
	10 to 170
	Same as in Example 1 except for declaration of Status_byte.
	190 to 240
	The new Wait_to_settle subroutine.
	200
	Start REPEAT loop.
	210
	Send the *STB? command to the switch. This queries the switch to return the value of the status byte.
	220
	Read the status byte.
	230
	If the LSB (Least Significant Bit) of the status byte is 0 (that is, the switch is settled), exit the loop. If the LSB is 1 (that is, the switch is moving), then loop back to line 200.
	240
	Return from subroutine.

Example 3: Switch position using the *OPC command

This program is identical in functionality to the first two example programs, except that it uses yet another method for determining when the switch is settled. This settling method sends the *OPC command before the ROUTE:LAYER:CHANNEL commands and then reads the Standard Event Status Register repeatedly until bit 0 is set to one.

Listing	<pre> 10 INTEGER Switch_addr,A_position,B_position,Esr_byte 20 DIM Command\$(80),Channel\$(80),Error_return\$(80), Config\$(80) 30 Switch_addr=711 40 CLEAR SCREEN 41 OUTPUT Switch_addr;"SYSTEM:CONFIG?" 42 ENTER Switch_addr;Config\$ 43 PRINT "SWITCH CONFIG = "&Config\$ 50 INPUT "Enter A-port position : ",A_position 60 INPUT "Enter B-port position : ",B_position 70 Channel\$="A"&TRIM\$(VAL\$(A_position))&"B"&TRIM\$(VAL\$(B_position)) 80 Command\$="ROUTE:LAYER1:CHANNEL "&Channel\$ 81 OUTPUT Switch_addr;"*OPC" 90 OUTPUT Switch_addr;Command\$ 100 GOSUB Wait_to_settle 110 REPEAT 120 OUTPUT Switch_addr;"SYSTEM:ERROR?" 130 ENTER Switch_addr;Error_return\$ </pre>
----------------	--

Programming Examples

```

140     PRINT Error_return$
150  UNTIL (VAL(Error_return$)=0)
170  GOTO Exit_prog
180  !
190 Wait_to_settle: ! wait for switch to settle
200  REPEAT
210     OUTPUT Switch_addr;"*ESR?"
220     ENTER Switch_addr;Esr_byte
230  UNTIL BIT(Esr_byte,0)
240  RETURN
250  !
260 Exit_prog: !
270  END

```

Description

<u>Line No.</u>	
10 to 170	Same as in Example 1 except for declaration of Esr_byte.
190 to 240	The new Wait_to_settle subroutine.
200	Start REPEAT loop.
210	Send the *ESR? command to the switch. This queries the switch for the Event Status Register value.
220	Read the value of the Event Status Register.
230	If the LSB of the ESR is 1 (that is, the switch is settled), exit the loop. If the LSB is 0 (that is, switch is moving), then loop back to line 200.
240	Return from subroutine.

Example 4: Input/output multiplexers

This program illustrates how two Agilent 86060C-series switches may be used to function as input and output multiplexers in an automated test system. For this example, two 1 × 8 switches are used to test 8 optical devices under test. The block diagram for this test system is shown below.

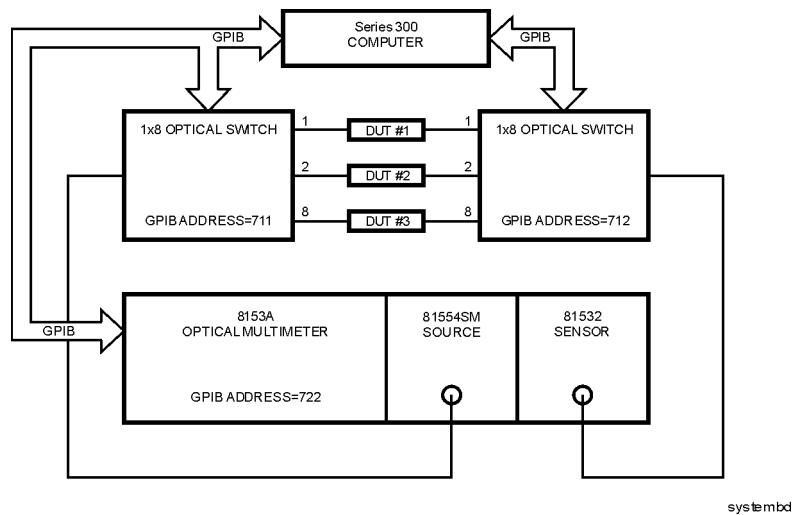

Block diagram of the test system

This example test system uses an Agilent 8153A optical multimeter equipped with an Agilent 81554SM laser source and an Agilent 81532A optical sensor. This program periodically (every 5 minutes) measures the optical power through each device under test and displays an error message if any measured power drops below 1 microwatt.

Listing

```

10  INTEGER In_switch_addr,Out_switch_addr,
    Opt_meter_addr
20  INTEGER Meas_count,Current_dut
30  REAL Watts_read,Min_power
40  DIM In_switch$(80),Out_switch$(80),Dummy$(50)
50  !
60  CLEAR SCREEN
70  PRINT "THIS PROGRAM MEASURES ALL DUT POWERS EVERY 5
    MINUTES."
80  PRINT "IT WILL STOP MEASURING AFTER 50 MEASUREMENT
    CYCLES."
90  PRINT "TO HALT PROGRAM EARLIER, PRESS F8."
100 !
110 GOSUB Init_system
120 !
130 ON TIME 300 GOSUB Measure_duts
140 ON KEY 8 LABEL "QUIT" GOT0 End_prog
150 !
160 Meas_count=0

```

Programming Examples

```

170 REPEAT
180 UNTIL Meas_count=50
190 GOTO End_prog
200 !
210 Init_system:! Initialize GPIB instruments
220 CLEAR (7) ! clear GPIB interface
230 ! set GPIB instrument addresses
240 In_switch_addr=711
250 Out_switch_addr=712
260 Opt_meter_addr=722
270 ! set minimum power allowed to 1 microwatt
280 Min_power=1.E-6
290 ! Turn on autoranging
300 OUTPUT @Opt_meter_addr;"SENSE2:POWER:RANGE:AUTO
ON"
310 ! Select Watts as output units
320 OUTPUT @Opt_meter_addr;"SENSE2:POWER:UNIT WATT"
330 ! Select 1550 nm wavelength from source
340 OUTPUT @Opt_meter_addr;"SOURCE1:POWER:WAVELENGTH
UPPER"
350 RETURN
360 !
370 !
380 Measure_duts:! measure all eight duts
390 ! Turn on laser
400 OUTPUT @Opt_meter_addr;"SOURCE1:POWER:STATE ON"
410 ! step through and measure all DUTs
420 FOR Current_dut=1 TO 8
430 ! build gpib commands to send to switches
440 In_switch$="ROUTE:LAYER1:CHANNEL
B"&TRIM$(VAL$(Current_dut))
450 Out_switch$="ROUTE:LAYER1:CHANNEL
B"&TRIM$(VAL$(Current_dut))
460 ! send command to switches
470 OUTPUT @In_switch_addr;In_switch$
480 OUTPUT @Out_switch_addr;Out_switch$
490 ! wait for switches to settle
500 OUTPUT @In_switch_addr;"*WAI"
510 OUTPUT @In_switch_addr;"SYSTEM:CONFIG?"
520 ENTER @In_switch_addr;Dummy$
530 OUTPUT @Out_switch_addr;"*WAI"
540 OUTPUT @Out_switch_addr;"SYSTEM:CONFIG?"
550 ENTER @Out_switch_addr;Dummy$
560 ! measure optical power
570 OUTPUT @Opt_meter_addr;"READ2:POW?"
580 ENTER @Opt_meter_addr;Watts_read
590 IF (Watts_read<Min_power) THEN
600 PRINT USING ""DUT
#"" ,K,"" Power

```



```

        Low!""";Current_dut
610     END IF
620     NEXT Current_dut
630     Meas_count=Meas_count+1
640     RETURN
650     !
660 End_prog:! quit program
670     ! turn off time initiated branching
680     OFF TIME
690     END

```

Description

<u>Line No.</u>	
10 to 40	Declare some variables to use in program.
60 to 90	Clear screen and print heading.
110	Call <code>Init_system</code> subroutine.
130	Set up time initiated branching. Every 300 seconds, <code>Measure_duts</code> subroutine will be called.
140	Set up function key initiated branching. When f8 is pressed, program will end.
160	Initialize measurement counter to zero.
170 to 180	Loop, waiting for events, until measurement count gets to 50.
190	Exit program.
210 to 350	The <code>Init_system</code> subroutine.
220	Clear the GPIB bus.
240 to 260	Define GPIB addresses for input and output switches, optical multimeter.
280	Define <code>Min_power</code> to be 1 microwatt.
300 to 340	Configure optical multimeter to enable autoranging, set power units to Watts, and select the upper wavelength (1550 nm) on the source.
350	Return to calling line.
380 to 600	The <code>Measure_duts</code> subroutine.
400	Turn laser source on.
420 to 580	FOR-NEXT loop to step through and measure each of the

Programming Examples

	8 devices-under-test.
440 to 450	Create the GPIB commands to select the input and output switch positions to measure the current device-under-test. For example, if <code>Current_dut=3</code> then <code>In_switch\$</code> and <code>Out_switch\$</code> would equal <code>"ROUTE:LAYER1:CHANNEL B3"</code> . Note that since the switches are 1x8, it is not necessary to specify the position of the A ports.
500 to 550	Use the <code>*WAI</code> command to ensure both switches have settled.
570 to 610	Read the optical power from the optical multimeter. If this power is less than <code>Min_power</code> then print appropriate error message to screen.
630	Increment <code>Meas_count</code> .
640	Return to calling line.
660 to 690	<code>End_prog</code> subroutine. Turn off time-initiated branching and end program.

Spare Channel Replacement Procedure 5-4
Electrostatic Discharge Information 5-7

Servicing

This chapter provides a procedure to replace an internal fiber-optic cable with a spare cable. This procedure may be needed if a fiber-optic cable becomes damaged through improper connections. Spare fiber-optic cables are provided inside the lightwave switch.

Before servicing this lightwave switch, familiarize yourself with the safety markings on the instrument and the safety instructions in this manual. This instrument has been manufactured and tested according to international safety standards. To ensure safe operation of the instrument and the personal safety of the user and service personnel, the cautions and warnings in this manual must be heeded.

WARNING

Refer to the summary of safety considerations at the front of this manual.

WARNING

These servicing instructions are for use by qualified personnel only. To avoid electrical shock, do not perform any servicing unless you are qualified to do so.

WARNING

Failure to ground the lightwave switch properly can result in personal injury, as well as instrument damage.

WARNING

The opening of covers or removal of parts is likely to expose dangerous voltages. Disconnect the instrument from all voltage sources while it is being opened.

CAUTION

Electrostatic discharge (ESD) can damage or destroy electronic components. All work on electronic assemblies should be performed at a static-safe work station. [Refer to “Electrostatic Discharge Information” on page 5-7](#) for more information on preventing ESD.

Required service tools

To enable extra fiber/connector the following tools are required:

TORX driver	#15
TORX driver	#20

Spare Channel Replacement Procedure

CAUTION

This procedure is included so the instrument can be repaired quickly in the field. Performing this procedure violates the calibration seal. When spare fibers have replaced bad port fibers, the unit should be sent to an Agilent Technologies Service Center, at your earliest convenience, to have new port fiber/connectors spliced into the instrument and to have the instrument calibrated.

- 1 Disconnect the power cord from the instrument.
- 2 Remove the top cover using a #15 or #20 TORX driver.
- 3 Locate out the spare cable/connector. Refer to [Figure 5-1 on page 5-5](#) and [Figure 5-2 on page 5-6](#). The spare cable/connector is on the bottom of the switch assembly, secured with a tie-wrap. Remove the tie-wrap.

Switches with 50 channels or less have one spare fiber. Switches with more than 50 channels have two spare fibers, labeled S1 and S2.

- 4 Replace the defective port cable/connector assembly with the spare assembly. Note the label on the spare cable/connector and record the identification number (S1 or S2) for use later on in this procedure.

Identification number: _____

- 5 Replace the top cover.
- 6 Connect the power cord to the instrument. Turn the instrument on.
- 7 Press **Help**, then enter the model number of the lightwave switch from the keypad: 86060, 86061, or 86062.
- 8 Press the 4 key.
- 9 Perform this step *only* if the lightwave switch has multiple layers. Determine if the lightwave switch has multiple switch layers installed. (A switch layer is a switch matrix of “A” ports and “B” ports. Normal lightwave switches have only one layer installed.) If the rear panel shows more than one set of “A” ports and “B” ports, the instrument has multiple switch layers. The display will prompt

Spare Channel Replacement Procedure

you for the switch layer on which to install the spare fibers:

- Press 1 for layer 1
- Press 2 for layer 2

- 10** The display will prompt you to enter 1 for spare fiber 1, or 2 for spare fiber 2. You recorded this identification number in [Step 4](#).
- 11** The display will prompt you to enter the number of the front or rear panel channel to be replaced. Enter the number of the channel and press Enter.
The display will show the intended cable changes.
- 12** Press Enter to confirm the changes.

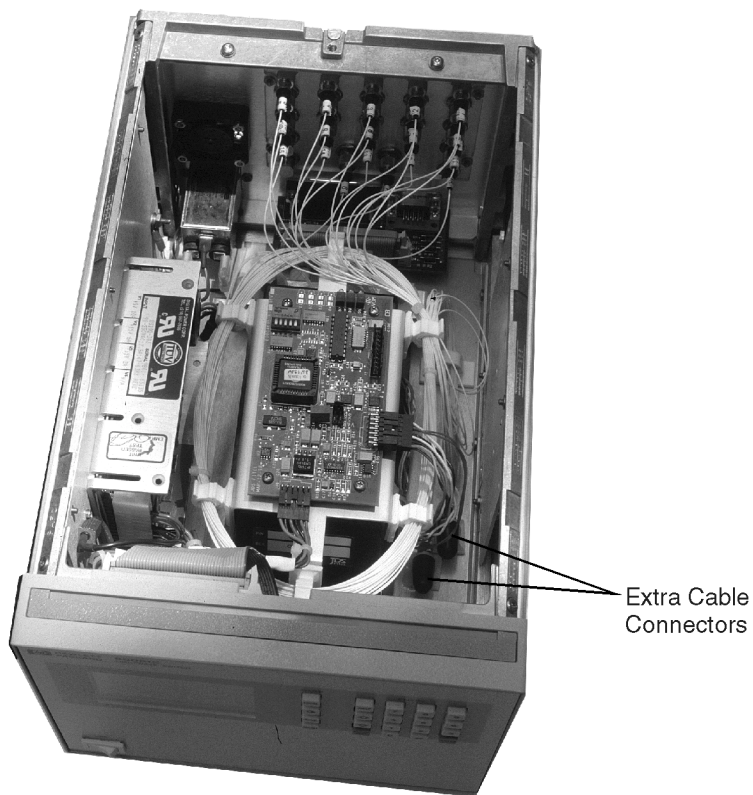

extra1

Figure 5-1. Top view of the Agilent 86060C or 86061C lightwave switch

Spare Channel Replacement Procedure

Extra Cable
Connectors

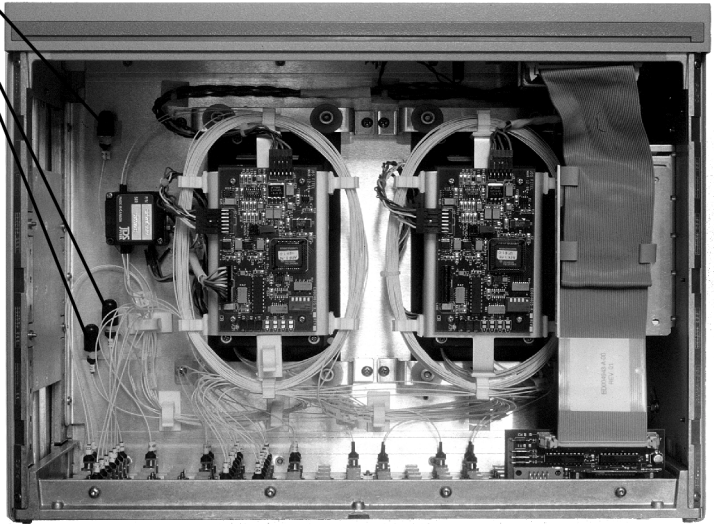
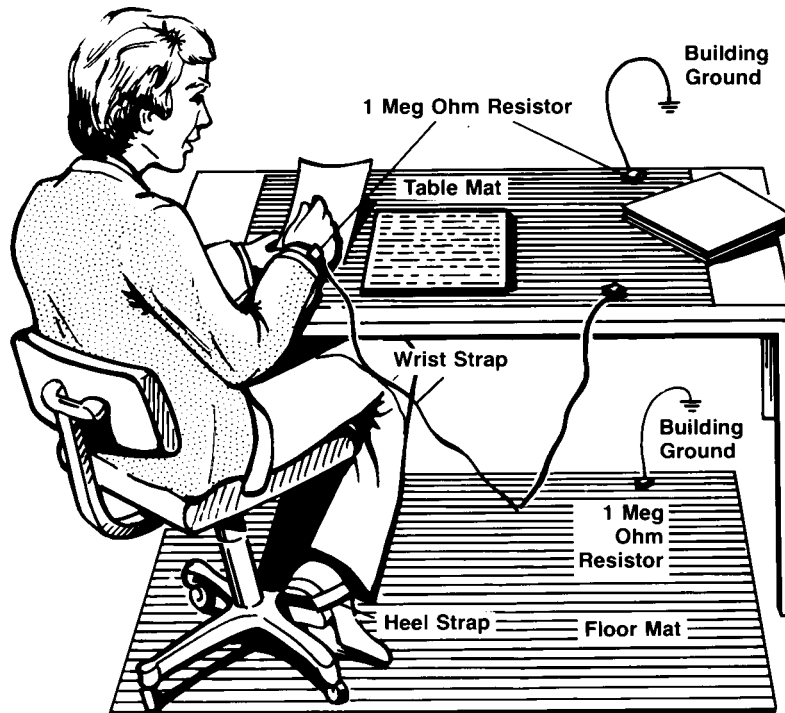

Figure 5-2. Top view of the Agilent 86062C lightwave switch

Electrostatic Discharge Information

Electrostatic discharge (ESD) can damage or destroy electronic components. All work on electronic assemblies should be performed at a static-safe work station. The following figure shows an example of a static-safe work station using two types of ESD protection:

- Conductive table-mat and wrist-strap combination.
- Conductive floor-mat and heel-strap combination.



Both types, when used together, provide a significant level of ESD protection. Of the two, only the table-mat and wrist-strap combination provides adequate ESD protection when used alone.

Electrostatic Discharge Information

To ensure user safety, the static-safe accessories must provide at least 1 M Ω of isolation from ground. Refer to [Table 3 on page 5-8](#) for information on ordering static-safe accessories.

WARNING

These techniques for a static-safe work station should not be used when working on circuitry with a voltage potential greater than 500 volts.

Reducing ESD Damage

The following suggestions may help reduce ESD damage that occurs during testing and servicing operations.

- Personnel should be grounded with a resistor-isolated wrist strap before removing any assembly from the unit.
- Be sure all instruments are properly earth-grounded to prevent a buildup of static charge.

Table 3. Static-Safe Accessories

Agilent Part Number	Description
9300-0797	Set includes: 3M static control mat 0.6 m \times 1.2 m (2 ft \times 4 ft) and 4.6 cm (15 ft) ground wire. (The wrist-strap and wrist-strap cord are not included. They must be ordered separately.)
9300-0980	Wrist-strap cord 1.5 m (5 ft)
9300-1383	Wrist-strap, color black, stainless steel, without cord, has four adjustable links and a 7 mm post-type connection.
9300-1169	ESD heel-strap (reusable 6 to 12 months).

Numerics

3-wire interface, 4-9
50/125 mm multimode fiber, 1-3
62.5/125 mm multimode fiber, 1-3
9/125 mm single-mode fiber, 1-3

A

Accessories, 1-6
accessories, 1-6
address
 GP-IB, 4-6
Agilent 86060C, 1-2
Agilent 86061C, 1-2
Agilent 86062C, 1-2
Agilent maintenance contract, 2-10
Agilent offices, 1-25
altitude, 1-9

B

before servicing the Agilent 86060C, 2-10

C

cabinet, cleaning, i-iii
cables, 1-3
cables, RS-232, 4-8
calibration cycle, 1-7
care
 of cabinet, i-iii
channels
 number of, 1-4
 unused, i-iii, 1-2, 3-2, 4-27
characteristics, 1-7
checking the fuse, 2-4
classification
 product, i-iii
cleaning
 adapters, 1-21
 cabinet, i-iii
 fiber-optic connections, 1-12, 1-20
 non-lensed connectors, 1-20
CLOSE RS232 COM command, 4-10
command
 instrument specific, 4-3
 standard SCPI, 4-3
 types, 4-3

communicating, RS-232, 4-10
compressed dust remover, 1-19
connector
 care, 1-12
contrast key, 3-3
cotton swabs, 1-19

D

damaged shipment, 2-3
data bits, 4-9
declaration of conformity, 1-11
display, 3-3
dust caps, 1-20

E

electrostatic discharge, 5-7
EMI compatibility, 1-9
error messages, 4-30
ESD
 reducing damage caused by ESD, 5-8
 static-safe work station, 5-8
extra fiber connector, replacing, 5-4

F

fiber optics
 cleaning connections, 1-12
 connectors, covering, 1-23
fiber type, 1-3
fiber-optic cable, spare, 5-2
foam swabs, 1-19
front panel
 features, 3-3
 optical input connector, 1-9
 output connector, 1-9
fuse, 2-4
 values, i-iv

G

GP-IB
 address, 4-6
GPIB
 address, 4-6
 bus command, 4-7
 command mode, 4-6

Index

- data mode, 4-6
- instrument address, 4-7
- interface clear command, 4-7
- interface select code, 4-7
- lockout mode, 4-7
- programming over, 4-6

H

- HELP key, 3-3
- humidity, 1-9

I

- IEC Publication 61010-1, i-iii
- initial inspection, 2-3
- input
 - connector, 1-12
- input voltage, 2-5
- insertion loss, testing, 2-8
- installation category, 1-9
- instrument
 - returning for service, 1-22
- instrument specific commands, 4-26
 - definition, 4-3
- interface
 - 3-wire, 4-9
 - operation, 4-8
 - settings, 4-9

L

- LCD contrast, adjusting, 3-7
- line
 - frequency, 2-5
 - fuse, 2-4
 - power, input connector, 2-4
 - power, requirements, 2-5
- LINE switch, 3-3
- line-power
 - cables, 2-6
- LOCAL key, 3-4, 4-6

M

- multimode fiber, 1-3

N

- noise declaration, 1-10

O

- OFF position, 1-3
- OPEN RS232 COM command, 4-10
- operation, interface, 4-8
- operational check, 2-8
- Option 025, 1-2, 2-2
- Option 109, 1-3
- Option 153, 1-3
- Option H51, 1-3
- Options, 1-5
- options, 1-5

P

- packaging for shipment, 1-23
- pigtail connections, 1-2, 2-2
- pollution degree, 1-9
- power
 - cable, 2-5
 - requirements, 1-9

Q

- query response, 4-4

R

- rear-panel features, 3-5
- RECALL key, 3-4
- recalling switch states, 3-7
- regulatory information, 1-7
- repair options, 2-10
- replacement procedures, 5-4
- return loss, testing, 2-8
- returning for service, 1-22
- RS-232
 - cables, 4-8
 - CLOSE, 4-26
 - communicating over, 4-10
 - OPEN, 4-26
 - programming over, 4-8

S

- safety, i-iii
 - laser classification, i-iii
- sales and service offices, 1-25
- SAVE key, 3-4
- saving switch states, 3-7
- screen-saver, 2-7, 3-3
- serial number, 1-4, 2-3
- serial numbers, 1-3
- service, 1-22
 - replacement procedure, 5-4
 - returning for, 1-22
 - sales and service offices, 1-25
- service options, 2-10
- service tools, 5-3
- shipping
 - procedure, 1-22
- single-mode fiber, 1-3
- spare fiber
 - installation, 5-4
- spare fiber-optic cables, 5-2
- specifications, 1-7
- standard SCPI commands
 - definition, 4-3
- swabs, 1-19
- SWITCH PORT key, 3-4
- switching, 1-3

T

- temperature range, 1-9
- turning on the lightwave switch, 2-7

V

- VA, power requirements, 2-5

W

- warranty, 2-10

